

Dell™ PowerVault™ 160T Tape Library User's Guide

[Introduction](#)

[Getting Started](#)

[Understanding the User Interface](#)

[Working With Cartridges and Barcodes](#)

[Configuring the Library](#)

[Running Your Library](#)

[Frequently Asked Questions](#)

[Maintaining Your Library](#)

[Troubleshooting](#)

[Getting Help](#)

[Contacting Dell](#)

[Specifications](#)

Information in this document is subject to change without notice.

© 2003 Dell Inc. All rights reserved.

Reproduction in any manner whatsoever without the written permission of Dell Inc. is strictly forbidden.

Trademarks used in this text: *Dell*, the *DELL logo*, and *PowerVault* are trademarks of Dell Inc. *Microsoft*, *Windows NT*, and *Windows* are registered trademarks of the Microsoft Corporation. *UNIX* is a registered trademark of The Open Group of the United States and other countries. Red Hat is a registered trademark of Red Hat, Inc.

Other trademarks and trade names may be used in this document to refer to either the entities claiming the marks and names or their products. Dell Inc. disclaims any proprietary interest in trademarks and trade names other than its own.

Initial release: August 2003

[Back to Contents Page](#)

Introduction: Dell™ PowerVault™ 160T Tape Library User's Guide

- [Other Documents You Might Need](#)
- [Explanation of Symbols](#)
- [Obtaining Technical Assistance](#)
- [Description](#)
- [Features](#)
- [Control Module](#)
- [Expansion Modules](#)
- [Host Attachment](#)
- [Management](#)

This manual contains information and instructions necessary for the operation of the PowerVault 160T Tape Library.

Other Documents You Might Need



PowerVault 160T Unpacking Instructions (Dell Service only)

PowerVault 160T Installation Guide (Dell Service only)

-  The *System Information Guide* provides important safety and regulatory information. Warranty information may be included within this document or as a separate document.

Explanation of Symbols

The following symbols and highlighted passages note important information:

Symbol	Description	Definition
	CAUTION:	A CAUTION indicates a potential for property damage, personal injury, or death.
	NOTICE:	A NOTICE indicates either potential damage to hardware or loss of data and tells you how to avoid the problem.
	NOTE:	A NOTE indicates important information that helps you make better use of your storage device.

Obtaining Technical Assistance

Dell Enterprise Training and Certification is now available; see www.dell.com for more information. This service may not be offered in all locations.

Description

The Dell PowerVault 160T Tape Library automates the retrieval, storage, and control of cartridge tapes. Cartridges are mounted and retrieved in tape drives using application software from the host without operator intervention.

The library has a standard 19-inch rack footprint and can be placed in a typical server rack space. All functions are accessible from the front and back doors. The library can be installed on a solid or a raised floor.

The smallest configuration consists of one control module. As storage and tape drive requirements change, you can scale from 264 LTO tapes to 1,344 LTO tapes and up to 48 LTO drives by adding expansion modules to the control module. These numbers vary by drive type. A fully expanded library with one control module and three expansion modules shares a single, barrier-free robotics system that eliminates the need for pass-through ports, see [Figure 1](#).

Figure 1. Dell PowerVault 160T Tape Library (Front View)

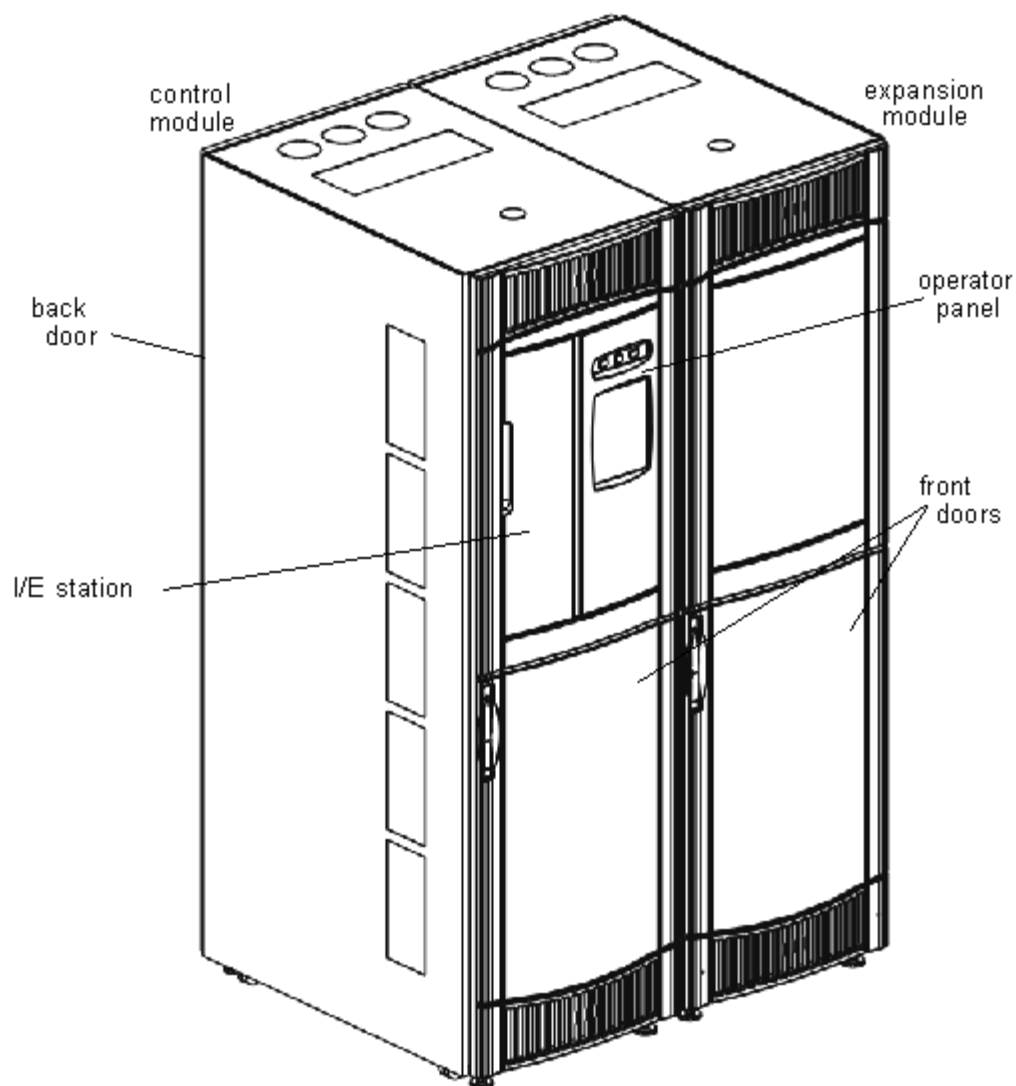

Features

The following subsections describe the features of the Dell PowerVault 160T:

Scalability

Your library can consist of a single control module, which makes about 264 storage cells available. You can add up to three expansion modules, with 350 or more storage slots per module for an overall storage maximum of 1344 cartridges.

Density

This library provides a storage density of 720 LTO cartridges per square meter. Storage density numbers vary by drive type. Each module, or frame, has two storage racks, a rack on the drive side and a rack on the door side. Each storage rack has ten sections. The size of a section is the size of the magazine for a particular media type. For LTO, for example, there are six rows per section. Four columns, each the width of a section, are distributed across the rack.

Centralized Management

The Library Management Console gives you a single point from which to view all library components: robotics, drives, and network connectivity. This graphical user interface can be run both locally and remotely. It uses a simple, intuitive graphical style that is both secure and powerful. It provides library managers with native partitioning ability and a rich SNMP-based policy engine.

Proactive Availability

The library can alert you of problems before they occur. The complete data path is checked at user-defined intervals in order to ensure that it is functioning before backup begins. The six major subsystems—drives, power, robotics, cooling, connectivity, and control—are all monitored by the system. Notifications of problems can be configured to be sent to the Library Management Console client, to an e-mail account, or directly to Dell support personnel. For more information on the monitoring and reporting capabilities of the library, refer to [Maintaining Your Library](#).

Reliability

The library has industry leading reliability features. The drives, power supplies, and fans are all hot swappable. Redundant power supplies are standard.

Your backup system and path sit idle most of the time. When backup begins, the system is used intensively at maximum bandwidth. Since you have the benefit of the proactive alerts that the library issues, you know that any problems have been identified and solved before backup begins. For more information about reliability features of the library, refer to [Troubleshooting](#).

SAN Backup

Storage networking support is built into the library. Fibre Channel throughput results in huge amounts of data being quickly and safely stored.

Control Module

The control module is a required library component. It contains the following components (see [Figure 2](#)):

- Library management module
- Cartridge accessor
- Import/Export station
- Tape magazines
- Tape cartridge slots
- Tape drives
- Operator panel
- Power

Figure 2. Control Module (Internal View)

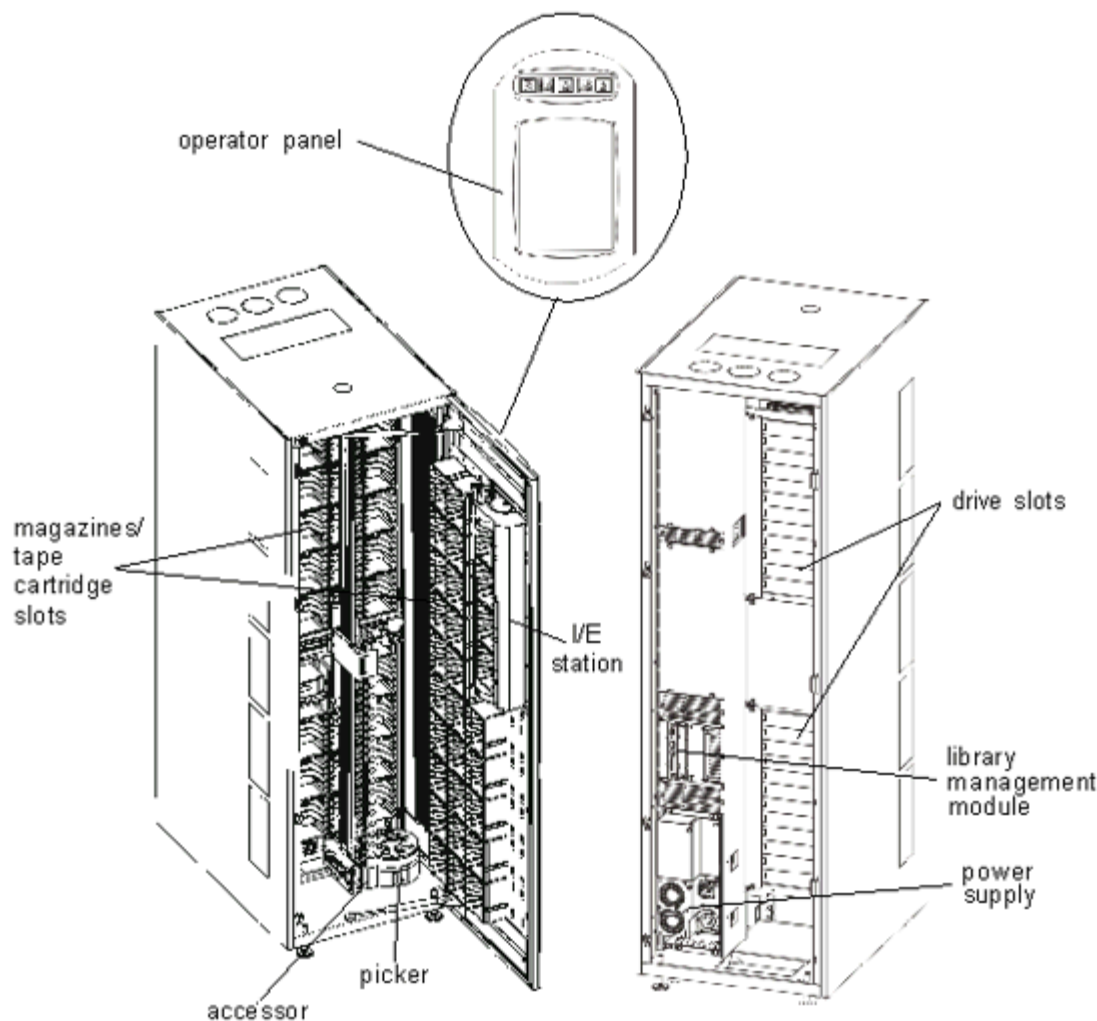

Library Management

Control of the library originates in the library management module. It manages system hardware and allows external devices to configure the library and to obtain system status.

Cartridge Accessor

The cartridge accessor moves cartridges between storage cells, tape drives, and the I/E station. A picker is used to get or put cartridges in a storage cell or a tape drive slot. The picker moves along an X and Y axis and can pivot 180°. A barcode scanner on the picker assembly identifies cartridges and storage cells.

Import/Export Station

The I/E station allows you to import and export cartridges without interrupting normal library operation. The I/E station is located on the front of the control or expansion module. See [Figure 1](#). Each I/E station has a capacity of 24 LTO cartridges located in four removable magazines. Capacity varies by drive type.

NOTE: The I/E station cannot be configured as a storage location

Cartridge Magazines

The cartridge magazine is a storage assembly located on the drive or door side of the control or expansion module. The control module can house a maximum of 264 LTO slots. Capacity varies by drive type. See [Figure 3](#).

Each tape magazine has a barcode label that the barcode scanner reads for identification and inventory. An optional, snap-on dust cover is available for the magazines. The magazines with the dust cover have interlocked stacking for external media storage.

Figure 3. Magazine and Drive Locations

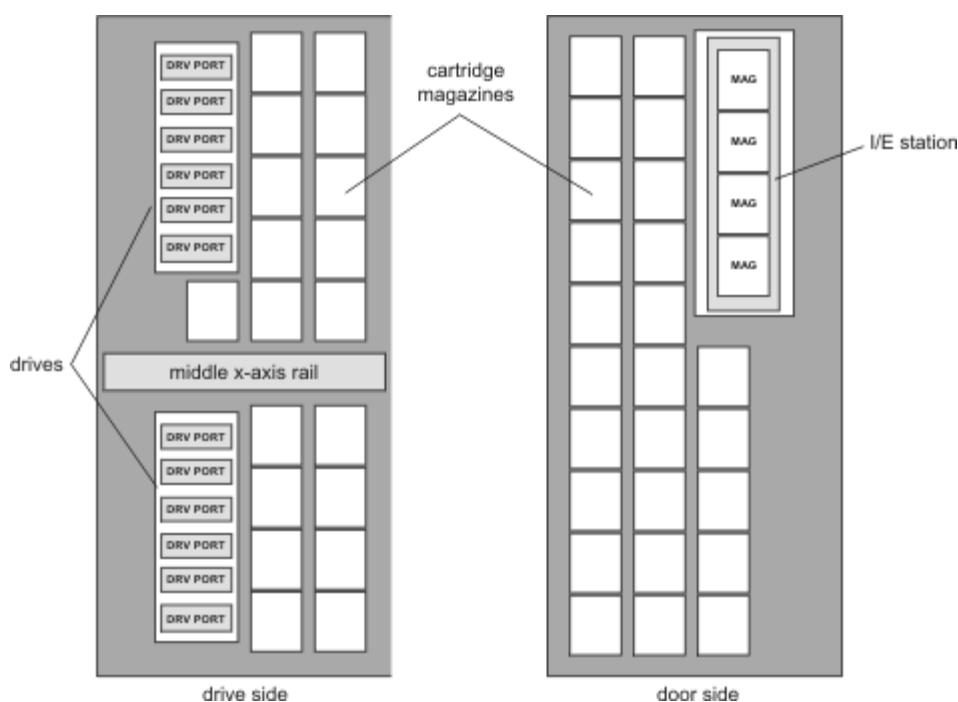

Tape Cartridges

Tape cartridges are stored in magazines within the library and are identified by an operator-attached, machine-readable barcode label. The library currently supports Code 39 type labels. The barcode label can have up to 16 characters.

Tape Drives

The library supports IBM LTO-1 or LTO-2 FC Multimode tape drives

NOTICE: The Dell PowerVault 160T does not support mixing drive types. This includes mixing LTO-1 and LTO-2 drives.

The control module has an upper and a lower drive cluster. The control module must include at least one tape drive. Each drive cluster can house up to six full-height, tape drives for a total of 12 drives. Drives are installed from bottom to top in the lower and upper drive clusters. See [Figure 3](#).

NOTE: The term *drive cluster* defines a grouping of up to six tape drives above or below the middle x-axis rail.

The tape drives are enclosed in a universal drive sled. You can hot swap all drives.

Operator Panel

The operator panel is located on the front of the control module and consists of the button/indicators and the touch screen. For more information on the operator panel and Library Management Console, refer to [Operator Panel](#) and [Library Management Console](#).

Power System

The library supports a redundant power configuration. This configuration has dual AC line input and dual DC power supplies. Redundant power configuration means you can hot swap a power supply.

The power system consists of the following:

- Power supply
- Power distribution unit (PDU)
- AC power cord

A single power switch, located on the front door, turns on and off all power for the control module and attached expansion modules. Each PDU has a second circuit breaker, located in the rear of the module, that controls the module power supply output. The power supply has three LEDs that provide status information. The power system also has four fuses for system protection.

Expansion Modules

Expansion modules allow the library to expand to accommodate additional tape drives and cartridge capacity. Each expansion module adds up to 360 LTO storage slots depending on the number of tape drives ordered and if an optional I/E station is installed, see [Figure 4](#). Capacity varies by drive type. The library's maximum configuration includes up to three expansion modules.

The expansion module can accommodate the following functional units:

- Tape drives
- Cartridge storage cells
- I/E station (optional)
- Redundant AC power compartment

Power supplies are not required in the expansion module unless the expansion module has tape drives. If an expansion module contains only cartridges, all power is derived from the control module.

Figure 4. Expansion Module

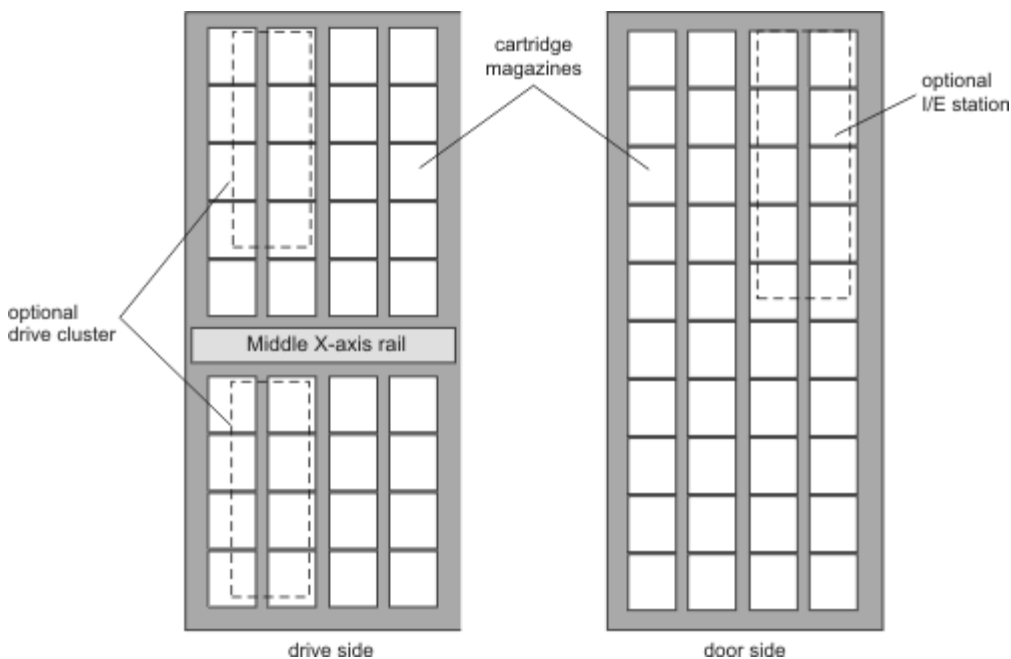

Host Attachment

Requests issued from the host application result in cartridge movement in the library. The primary requests issued are for mounting and dismounting cartridges in and out of the tape drives and for importing and exporting cartridges in and out of the library. The library manages the physical location. In addition to requesting cartridge movement in the library, the host application can obtain status, configuration information, and cartridge storage information stored in the library.

Hosts can be directly attached to drives or they can be attached to a switch, which is then attached to the drives.

Management

The library can be managed locally or remotely using the Library Management Console (LMC). Locally, the LMC is displayed on the touch screen on the front of the library. Remotely, the LMC is accessed through a client instance of the SNC Manager software on any computer on the network. The local and remote LMC user interfaces are identical. For more information on the LMC, see [Library Management Console](#).

[Back to Contents Page](#)

[Back to Contents Page](#)

Getting Started: Dell™ PowerVault™ 160T Tape Library User's Guide

- [Cabling](#)
- [Installing Cartridges](#)
- [Installing Tape Drives](#)
- [Applying Power](#)
- [Logging on Locally](#)
- [Running the Setup Wizard](#)
- [Installing a Remote Client](#)

Cabling

The controlling host computer(s) connect directly to the drives and library. The management control blade (MCB) that is located in the control module controls library operation. The MCB has one library control port (SCSI or Fibre Channel) connecting to the controlling host computer. The MCB SCSI control port provides its own termination. Drives attach directly to host computers and are represented by their own unique SCSI ID or World Wide Name and LUN ID. The user interface client software communicates via an Ethernet connection to the localized server and agent running on the MCB.

A typical cabling scheme is shown in [Figure 1](#).

 **NOTE:** Cabling may be affected by partitioning or zoning changes. When cabling to drives, ensure that they are cabled to the correct hosts for the defined partitions.

Figure 1. Direct Attached Library With Fibre Drives



Cable management is accomplished through velcro clamps on the right-hand side of the library and a horizontal routing guide. Install the cables through these cable management devices.

Host Connection Considerations

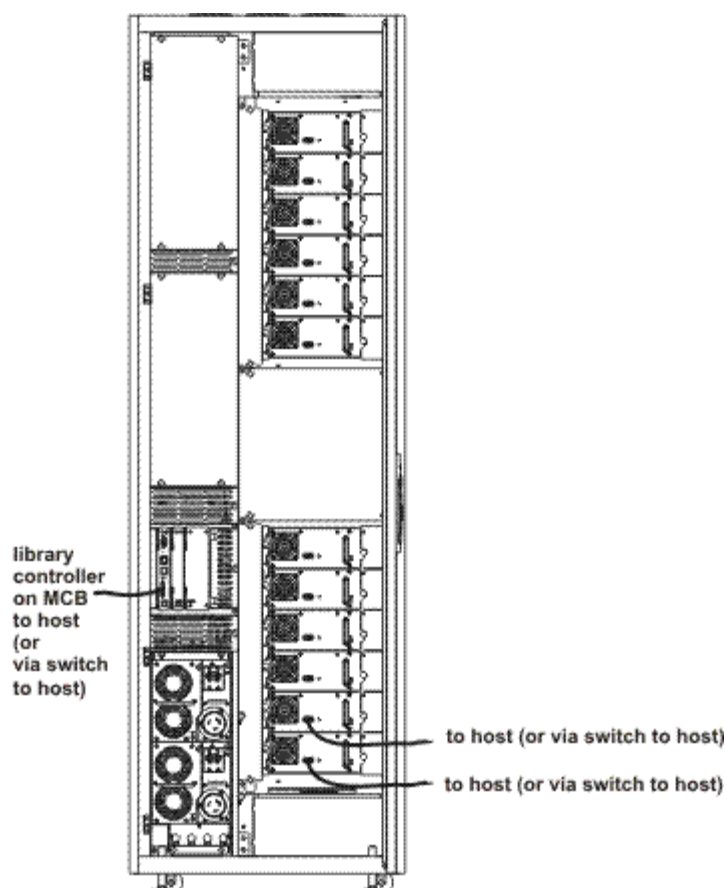
There are limitations on the number of hosts that can access a single drive at any one time, for example, Fibre Channel-attached drives support a minimum of two initiators.

The Ultrium tape drive model T200F (Fibre Channel drive) is an arbitrated-loop-only device (also known as an NL port). The drive supports Fibre Channel Arbitrated Loop (FC-AL) protocol, and uses Class 3 Service frames. The drive also supports both public (switch-attached) and private loops.

The library uses a LUN ID which is configured by using the Library Management Console FC Host and SCSI Host commands. Library partitions as well as drives are presented as devices to be mapped. SCSI IDs or cabling may affect which SCSI device map LUN is associated with which FC Host or SCSI Host LUN ID. Ensure that the device order is not altered when swapping drives, cables, or locations.



NOTE: The partition should map to a higher priority LUN than the drives.

Installing Cartridges

Before handling data cartridges, review the guidelines in [Working with Cartridges and Barcodes](#).

Cartridges can be loaded into the library in two ways:

- With the front door open, manually insert data cartridges in the desired location in the appropriate magazine.
- With the front door closed, manually insert tape cartridges in the I/E station and use the Library Management Console to import the cartridges.



NOTICE: If you have configured more than one partition, use the I/E station to import cartridges.

When installing cartridges:

- Make certain the barcode side is facing out of the slot. All cartridges must be labeled with a valid barcode label.
- Make certain that the cartridge is completely seated in the slot. Accessor motion can be impeded if the cartridge is not completely seated within the slot.
- Make sure that the media is not inserted in the slot upside down (see [Figure 2](#)).

Figure 2. Cartridge in Magazine

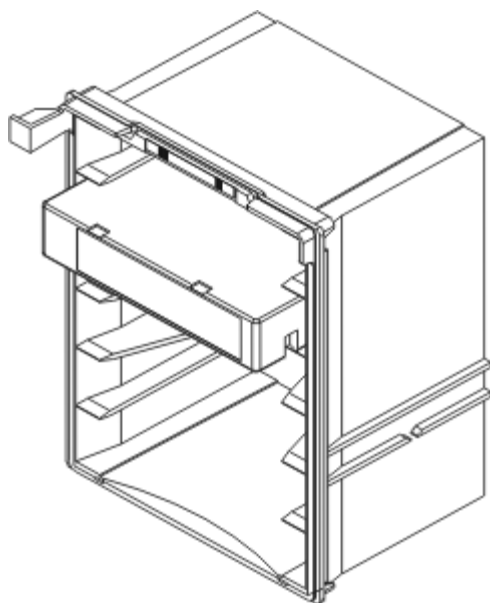

Installing Tape Drives

The library can contain up to 12 full-height and 24 half-height tape drives. Tape drives should be added moving bottom to top starting with the lower drive cluster (see [Figure 3](#)). When the lower drive cluster is filled, begin adding tape drives to the bottom position in the upper drive cluster.

Figure 3. Drive Installation Locations

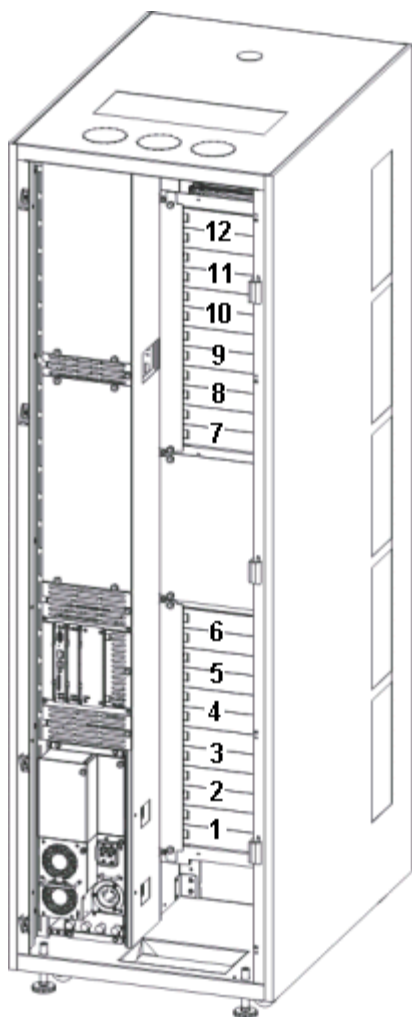

Required tools: 2.5 mm hex wrench, Phillips screwdriver

1. Open the front door.
2. Using a 2.5 mm hex wrench, unscrew the retaining screws (2 screws per plate) that secure the cover plate(s) over the target drive slot.
3. Close the front door.
4. Open the back door.
5. In the corresponding drive location, using the Phillips screwdriver or your fingers, unscrew the one retaining thumbscrew and remove the corresponding drive cover plate(s).
6. Using the markings on the drive slot, install the drive slowly so the guide rails engage. The installed drive should be flush with no gaps above or below it.

Use the bottom of the empty drive cluster as a guide if you are installing a drive in the Drive 1 or Drive 7 position. If a drive is installed below the slot where you are adding a drive, use the top of the drive below as a guide. For example, if you are adding a drive in Drive 9, use the drive in Drive 8 as a guide.

Figure 4. Fibre Channel Tape Drive

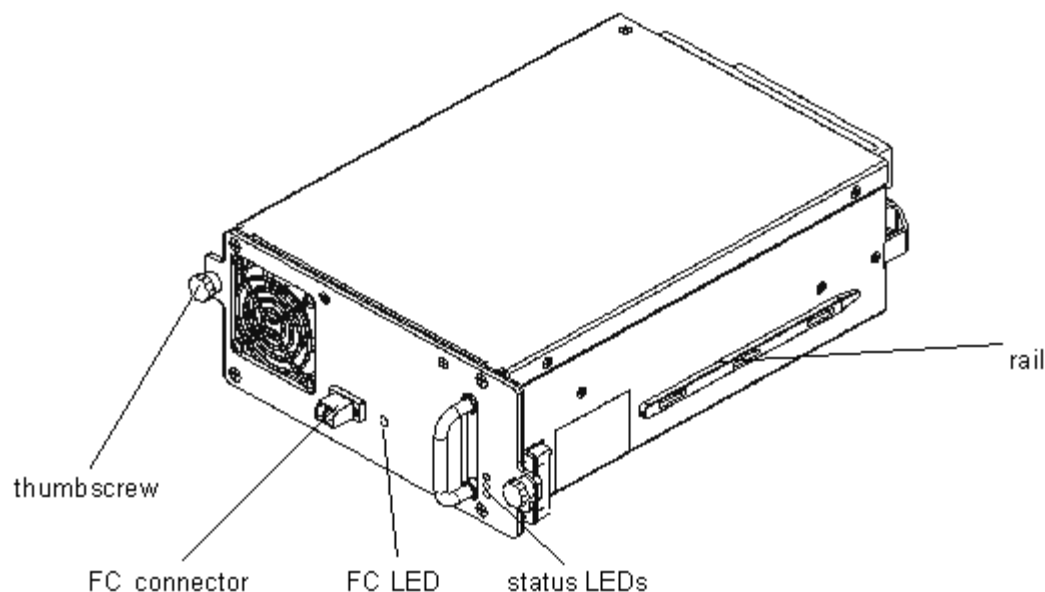

9. Using the Phillips screwdriver or your fingers, tighten the two retaining thumbscrews.
10. Install any further tape drives in the lower drive cluster. When the lower cluster is full, install the next tape drive in the upper drive cluster.
11. Close the back door.

Applying Power

Before applying power, you should perform a voltage check.

Required tools: digital volt meter

1. If the outlet case is conductive (metal), measure for 0 VAC from building ground to the outlet case.
2. Measure for 0 VAC from the ground pin of the outlet to the building ground.
3. Measure for less than 1 ohm resistance from the ground pin of the outlet to building ground and from the ground pin of the machine power cord to each module in the library.
4. Measure the supplied voltage. The nominal voltage is single-phased 110/220 VAC for the control module and 110/220 VAC for the expansion modules. Perform this measure for all outlets (one for each module).
5. Connect the ground wire, from the ground source to the ground point located on the control module (the ground point is marked with a ground symbol).

In Europe, use an industrial type plug that meets the IEC 309 requirement.

Turning on the Library

1. Plug the AC power cable(s) into the power distribution unit(s).
2. Plug the AC power cable(s) into a power source(s).
3. On the power distribution unit(s), set the circuit breaker switch labeled **Power** to the up (I) position. Fan power supplies will start but library power is not fully on.

Figure 5. Library Power Supply and Distribution

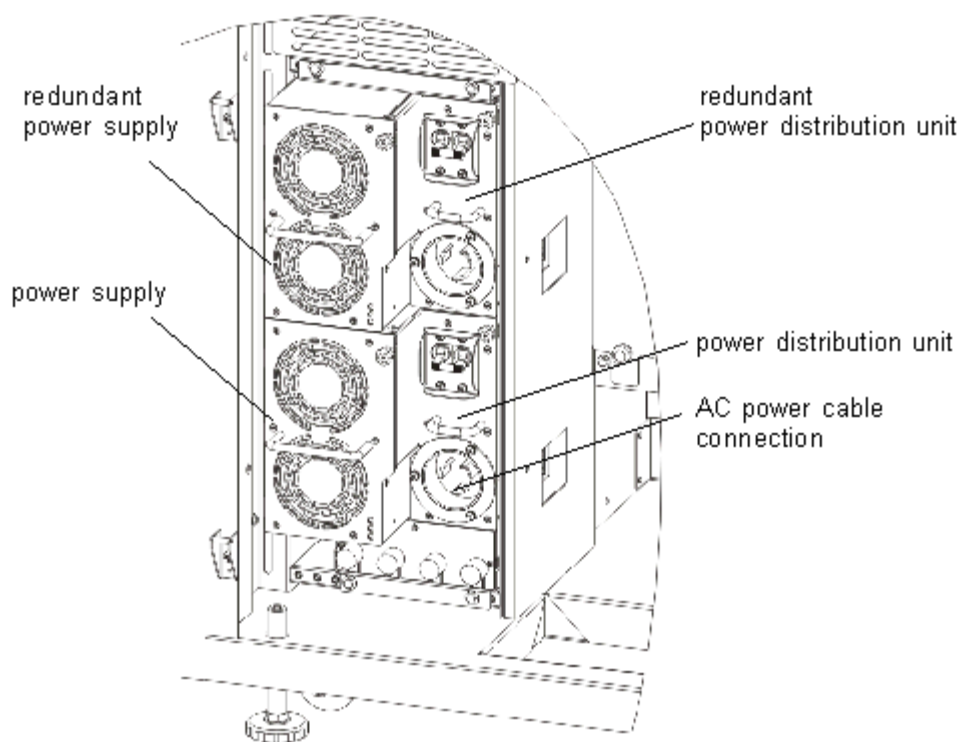

NOTES: It may take a few minutes for the library to fully power on and the Library Management Console to display.



During the power-on sequence, the **Robotics Enabled** indicator will flash. Once the system is fully up, the **Robotics Enabled** indicator will turn solid green. For more information, refer to [Indicator Panel](#).

Logging on Locally

After the system has finished booting, the **Logon** dialog box is displayed on the touch screen.

1. Touch the text box after the word **Name**.
2. Use the keyboard to enter the word **admin**.
3. Touch the box below the **Name** field.
4. Use the keyboard to enter the word **password**.
5. Touch **OK**.



NOTICE: After the initial log on, change the password for the **admin** account. For procedures, refer to [Modifying User Accounts](#).

6. Proceed to [Running the Setup Wizard](#).

Running the Setup Wizard

After you have logged on, the display will change to the Library Management Console. For a detailed description of management interface components, refer to [Understanding the User Interface](#).

Use the **Setup Wizard** to modify:

- Network Configuration
- Partitions
- Date and Time

The **Setup Wizard** does not include segments for configuring e-mail settings or setting up notification. It is recommended, however, that you refer to [Configuring E-mail Settings](#) and [Setting up Notification](#).

Once you have completed the **Setup Wizard**, configuration choices can be changed by using commands on the **Setup** menu.

 **NOTE:** You will not be able to manage the library from a remote system until you have logged on locally and run the **Setup Wizard**. After the **Setup Wizard** has configured your system, you can then perform all management tasks from a remote location. Refer to [Installing a Remote Client](#).

You can use separate menu commands to modify these features at a later time. For more information, refer to [Configuring the Library](#).

Setting Network Configuration

Be sure the library is connected to your network.

1. Before you launch the **Setup Wizard**, find out:
 - The name and/or IP address of your network's domain name server (DNS) or
 - The IP address, subnet mask and default gateway for your network segment.
2. Go to **Setup—> Wizard**.

When you are ready to continue, select **Next**.

3. The **Setup Wizard** prompts you to enter the appropriate network values.

You may have to consult with your network administrator to verify correct values.

- o If you have DHCP enabled on your network, select **Enable** and enter the DHCP server's name in the **Library Name** box.
- o If you do not have DHCP enabled on your network select **Disable** and enter the IP Address of the library in the **IP Address** box.
- o Enter the subnet mask and the IP address of the default gateway for your portion of the Ethernet network in the **Subnet Mask** and **Default Gateway** boxes, respectively.

4. Select **Next**.

Setting Partitions

The library allows you to define partitions to create what appears to a host as additional libraries separate from your physical library. For a discussion of the partition and its components, refer to [Working With Partitions](#).

The **Setup Wizard** automatically configures partitions according to media type and drive type. The first available storage segments, drives, and I/E slots are selected automatically and distributed evenly among partitions.

The **Setup Wizard** is used to automatically configure partitions. To complete the system configuration manually, refer to [Configuring the Library](#).

If partitions already exist, but you want to delete them, cancel the **Setup Wizard** and refer to [Configuring the Library](#).

 **NOTICE:** Whenever an existing partition is deleted, extreme care must be taken to recreate a partition that includes the same media type, interface, I/E station magazines, and a host at the same LUN, for the host application to have access to previously written data.

1. Select **Create**.

The **Partitions** dialog box is displayed.
2. Enter the number of partitions to create per media type in the column labeled **Partitions**.
3. Select **Next** to create the partitions.

The partitions are created and the **Setup Wizard** displays the **Date and Time** dialog box.

Setting the Date and Time

- In the **Date and Time** dialog box, set the following parameters:
 - Use the pull-downs to set the month, date, and year.
 - Use the pull-downs to set the hour, minute, and—because the clock is not a 24 hour clock—whether the time is am or pm.
- Select **OK**.

Configuring E-mail Notification

The **Notification** command allows you to send e-mail to specific individuals whenever certain conditions occur. It is not required to set up notification, but it is strongly recommended.

- Complete the steps in [Configuring E-mail Settings](#).
- Select **Setup**—> **Notification**.

The **Notification** dialog box is displayed.

The default notification address for Severity 1 issues is support@dell.us.com.

To delete an e-mail address, select the address in this dialog box, and then select **Delete**.

- Select **Create** to enter an e-mail address. The **New Email Notification** dialog box is displayed.
- Type in the e-mail address in the blank box after the words **Email Address**.

Do not enter multiple addresses into this box. To associate more than one e-mail address with events of a particular severity, repeat the **Create** process.

- Select the severity level that will be reported.

The severity levels are numbered from 1 to 5, with 5 being the least severe. If you specify level 3, notifications are not sent for events that are associated with levels 1, 2, 4, or 5. Level 5 represents a return to "Good" from "Degraded" or "Failed."

Table 1. Event Severity Levels

Level	Meaning
1	Failed
2	Degraded
3	Warning
4	Information
5	Good

You can select multiple severity levels by holding down shift and clicking each choice.

- Repeat [Step 2](#) to [Step 5](#) as often as necessary.
- Select **OK** on the **New Email Notification** dialog box.
- When your specifications have been completely entered, select **OK** on the **Notification** dialog box.

Installing a Remote Client

You can access your library remotely from any network computer by installing a remote version of the Library Management Console.

Installation Requirements

Microsoft Windows®

- Microsoft® Windows NT® 4.0 Server or Workstation, Service Pack 6a or Microsoft® Windows® 2000 or Microsoft® Windows® XP
- Minimum memory: 96 MB
- Free hard disk space: 30 MB
- Ethernet with TCP/IP protocol installed

Red Hat® Linux

The installation requirements for Red Hat® Linux include:

- Red Hat® Linux 8.0
- Minimum memory: 80 MB
- Free hard disk space: 60 MB
- Ethernet with TCP/IP protocol installed
- Video adapter board for graphical input

Installing a Client on a System Running Microsoft® Windows®

The client can be installed on a system running Microsoft® Windows® NT, Microsoft® Windows® 2000, or Microsoft® Windows® XP.

1. Load the product CD.
2. Click the install link under the SNC Manager 4.0.

 **NOTE:** Although the software is labeled "SNC Manager," by only installing the client, you will be installing a remote version of the Library Management Console.

3. Click **OK**.

This starts the InstallAnywhere program, which prompts you throughout the installation.

4. When you are prompted to choose an installation set, select **Client Only**.
5. Proceed to [Launching the Remote Client](#).

Installing a Client on a System Running Red Hat® Linux

1. Load the product CD.
2. Click the install link under the SNC Manager 4.0.

 **NOTE:** Although the software is labeled "SNC Manager," by only installing the client, you will be installing a remote version of the Library Management Console.

3. Click **OK**.
4. Open the folder and copy the image file to a temporary folder on the host.

 **NOTICES:** Verify that you have enough space, about 80 MB, in the temporary directory to be able to complete the installation. On client systems running Solaris, if the /tmp directory is not large enough for InstallAnywhere to operate, the installation fails, even if the temporary directory is resized later.

Set the IATEMPDIR environment variable to have the name of a directory which is large enough. Then InstallAnywhere will use that directory instead of /tmp.

To set the variable for Bourne shell (sh), ksh, bash and zsh:

```
$IATEMPDIR=/your/free/space/directory  
$ export IATEMPDIR -
```

To set the variable for C shell (csh) and tcsh:

```
$ setenv IATEMPDIR /your/free/space/directory
```

5. From the temporary folder, type: `chmod 777 <filename>`, for example,
`chmod 777 MC400SOL.bin`
6. If the temporary folder is NOT in the user's path, type `[space]./<filename>`, e.g.
`./MC400SOL.bin`

This launches the installation from the current directory.

If the temporary folder is in the user's path, simply type: `<filename>` (including extension), for example:

```
MC400SOL.bin
```

This starts the InstallAnywhere program, which prompts you throughout the installation.

7. When you are prompted to choose an installation set, select **Client Only**.

Launching a Remote Client

To manage your library remotely, point your client to the IP address of the library.

Use one of the following procedures to start the client, depending on the operating system your client is running:

Launching a Microsoft Windows® Client

1. If you accepted the defaults during the installation, select the **SNC Manager** program group on the **Start** menu to see the client icon. If you chose a program group other than the default, go there instead.
2. Select **Client** to launch the program.
3. Proceed to [Logging on Remotely](#).

Launching a Red Hat® Linux Client

1. To start the Red Hat® Linux client, start a terminal window and type

```
Client <enter>
```

and press **Enter**.

 **NOTICE:** Uppercase C is mandatory.

2. Proceed to [Logging on Remotely](#).

[Back to Contents Page](#)

[Back to Contents Page](#)

Understanding the User Interface: Dell™ PowerVault™ 160T Tape Library User's Guide

- [Operator Panel](#)
- [Library Management Console](#)
- [Menus](#)
- [Reading the Library Information Panel](#)
- [System Status at a Glance](#)

The Library Management Console allows you to interactively control library operations, set library options, check operating statistics, diagnose errors, and repair problems. This chapter contains an overview of the operating principles and command structures built into the library's graphical user interface.

Operator Panel

The operator panel on the library includes an indicator panel and a touch screen. The indicator panel consists of a **Robotics Enabled** button with its associated indicator, a **Status** indicator, and a **Power** button with its associated indicator. The Library Management Console is displayed on the touch screen.

Figure 1. Operator Panel

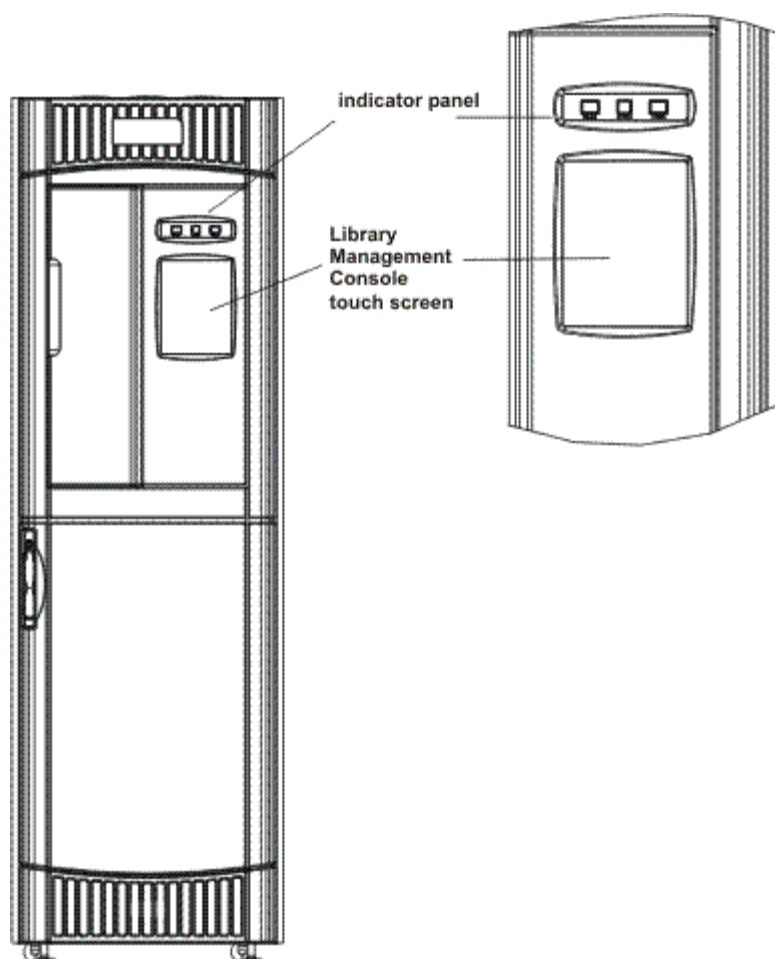

For an explanation of functions associated with the buttons and indicators, refer to [Indicator Panel](#).

For a brief overview of the Library Management Console, refer to [Library Management Console](#).

Indicator Panel

The **Robotics Enabled** indicator and the **Power** indicator each contain a button. The **Status** indicator is not a button. These indicators do not report the status of communications with a host.

Figure 2. Indicator Panel

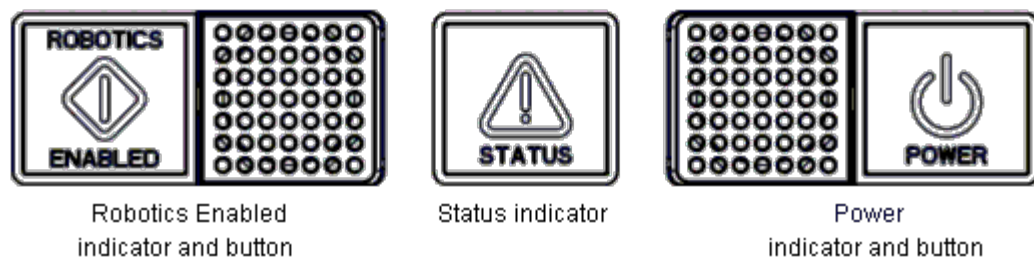

Table 1. Robotics Enabled Indicator

Indicator	Operational Status	Operator Attention
Green/Steady	The robotics are enabled to process or are actively processing commands from the library controller. Do not open the front door.	No attention required.
Green/Blinking	A state change is pending, either from Enabled to Not Enabled or from Not Enabled to Enabled . Do not open the front door.	No attention required.
Off	The robotics are not ready. The doors may be opened.	Attention required. The operator should close the doors and press the Robotics Enabled button to return to the Enabled state.

 **NOTE:** **Enabled** does not mean "communicating with the host." It means that the robot is communicating with the library controller.

Table 2. Status Indicator

Indicator	Operational Status	Operator Attention
Green/Steady	Normal	No attention required.
Amber/Blinking	Fault	Go to Tools—> Service . Attention required.
Off	No Power	Attention required. Power must be on to operate the library. Press the Power button.

Table 3. Power Indicator

Indicator	Operational Status	Operator Attention
Green/On	Power on	No attention required.
Off	Power off	Attention required. Power must be on to operate the library. Press the Power button.

Library Management Console (LMC)

The Library Management Console (LMC) can be viewed either on the touch screen or from a remote computer. If you are using the touch screen, you do not need to install the Library Management Console because it is pre-installed. To install the

Library Management Console on a remote system, refer to [Installing the Remote Client](#).

NOTE: You cannot manage your library from the remote console until you have logged on to the LMC that runs on the touch screen, and completed [Running the Setup Wizard](#) from there.

The LMC consists of five areas used to direct library activities: a title bar, a menu bar, a toolbar, the library information panel, and the system status buttons.

- The title bar on the touch screen consists of the Dell logo and the words, Dell PowerVault 160T Tape Library Management Console. The title bar as viewed from the remote console is a little different. Compare [Figure 3](#) to [Figure 4](#). The remote console is easier to use for screens that require text entry.
- The menu bar provides access to all the commands used to manage library functions.
- The toolbar displays the most commonly executed commands.
- The library information panel takes up most of the display to present operational data from the current library.
- System status buttons provide current information for the six subsystems of the physical library.

Figure 3. Library Management Console (Local Touch Screen)

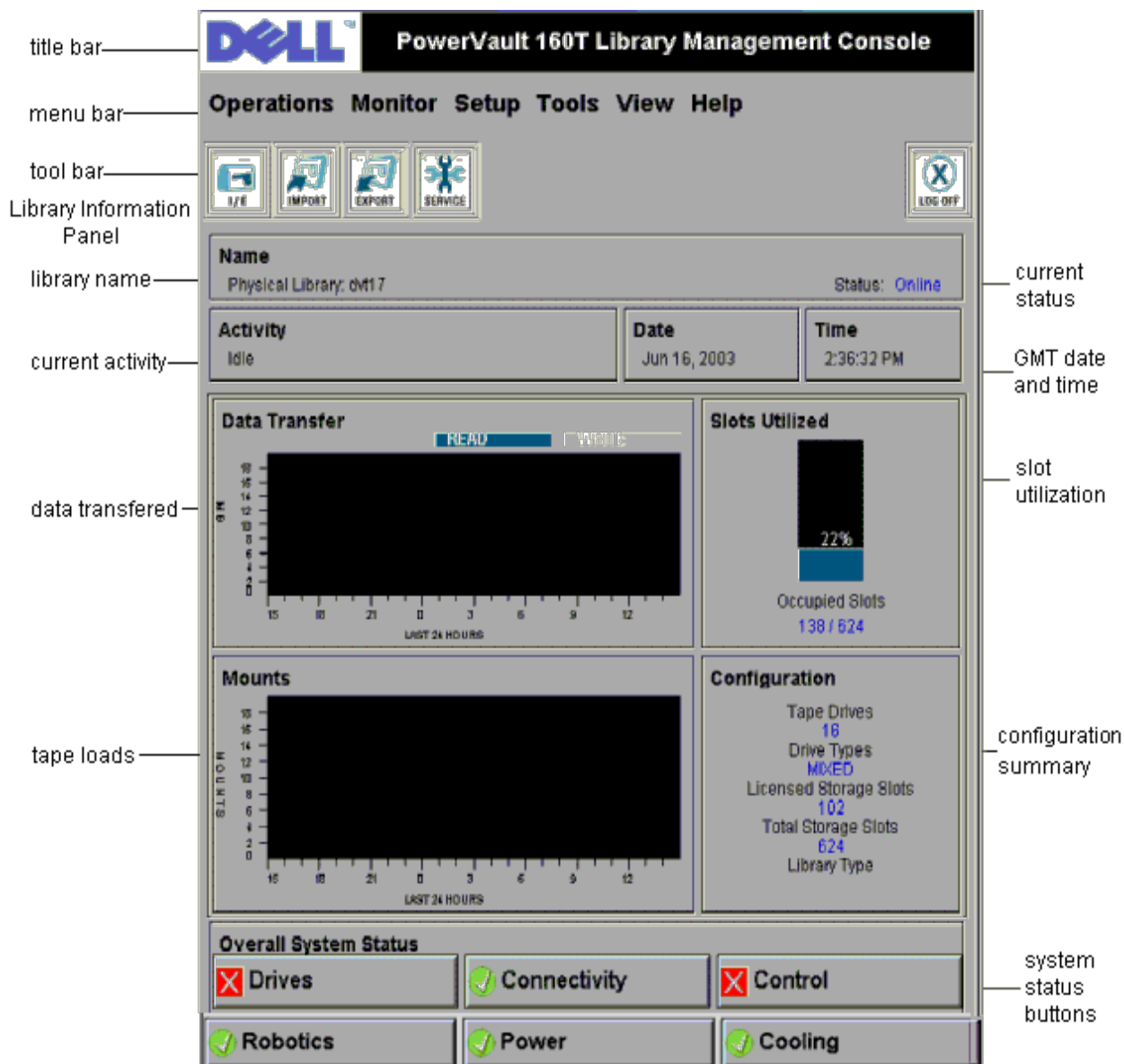
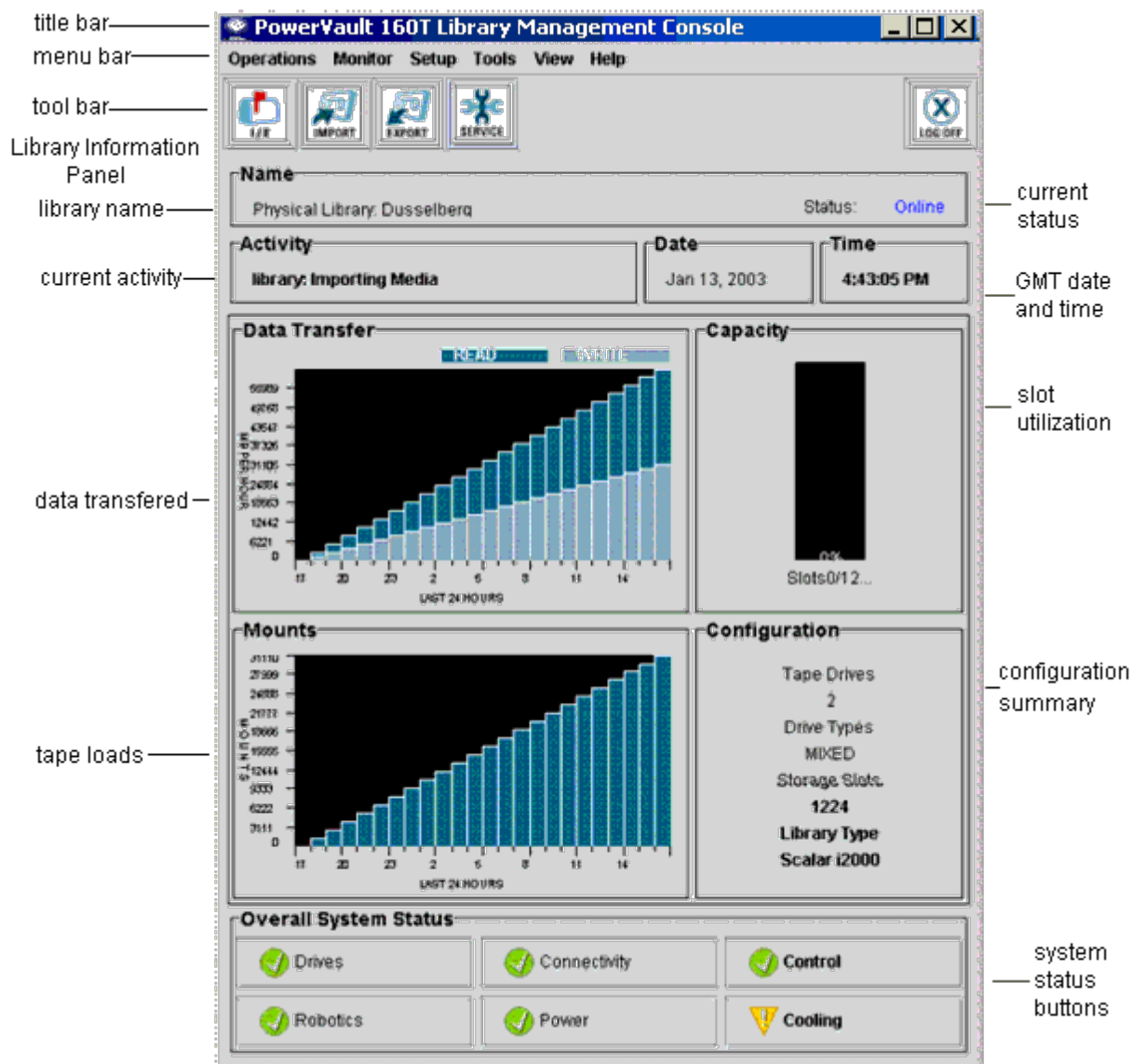

Figure 4. Library Management Console (Remote Console)



Menus

LMC menus organize user commands into six groups: **Operations**, **Monitor**, **Setup**, **Tools**, **View**, and **Help**.

Use the **Operations** menu for day-to-day operations, including: changing mode, importing and exporting cartridges, taking inventory, moving media; loading and unloading drives, and logging off.

Use the **Monitor** menu to view statistics at a glance as well as to get a detailed look at subsystem states. The choices include: system, drives, connectivity, I/E station, slot, and media.

Use the **Setup** menu to configure the library. This tool provides configuration assistance for the following parameters: partitions, device, connectivity, network configuration, physical library, users, notification, date and time, licenses, and e-mail configuration.

Use the **Tools** menu to access diagnostic and maintenance tools for the physical library. They include: service, connectivity, capture snapshot, and update software.

Use the **View** menu to specify the library—either physical or logical—information currently displayed in the Library Information panel.

Use the **Help** menu to access online help as well as to learn the software build number and copyright date.

Some operations pertain only to a physical library, some only to a partition, and others can be carried out on either entity. [Table 4](#) summarizes all available commands by required user privilege level and required library environment. LMC prompts you to take the library offline or to select the physical library if the command you are requesting requires you to change mode

or window.

Table 4. Menu Commands: Privileges and Environments

Menu Command	Privilege Level	Physical Library	Partition
Operations Menu			
Change Mode	Admin	X	X ¹
Import ²	Admin, User	X	X
Export ²	Admin, User	X	X
Drives ²	Admin, User		
Load ²			X
Unload ²			X
Move Media ²	Admin, User		X
Inventory ³	Admin	X ³	X ²
Logoff	Admin, User, Guest	X	X
Monitor Menu			
System	Admin, User	X	X
Drives	Admin, User	X	X
Connectivity	Admin, User	X	X
I/E station	Admin, User	X	X
Slot	Admin, User	X	X
Media	Admin, User	X	X
Setup Menu			
Setup Wizard	Admin	X	
Partitions ⁴	Admin	X	
Device	Admin	X	X
IDs ²	Admin		X
FC Host	Admin	X	
SCSI Host	Admin	X	
Connectivity ⁴	Admin	X	
Network Configuration	Admin	X	
Physical Library	Admin	X	
Users	Admin	X	
Notification	Admin	X	
Date and Time	Admin	X	
Licenses	Admin	X	

Tools Menu			
Service	Admin	X	
Drives ⁴	Admin	X	
Capture Snapshot	Admin	X	
Update Software ⁴	Admin	X	
Teach ⁴	Admin		
View			
[system name]	Admin, User, ¹ Guest ⁵		
Help			
Help	Admin, User, Guest	X	X
About	Admin, User, Guest	X	X

¹Users can make changes to or operate only those partitions to which they have privileges.

²Relevant partition must be offline and the physical library must be online.

³Physical library must be online.

⁴Physical library must be offline.

⁵Guest can read status off the display but cannot click the relevant status button for more detail.

The system status buttons are displayed at the bottom of the library information panel. If the touch screen goes unused for a period of time, the system status buttons operate as a screen saver. Users can see all states of the button statuses, but only administrators can pull up tickets associated with buttons in a degraded or failed state.

Table 5. System Status Buttons

System Status Button	Privilege Level	Physical Library	Partition
Drives	Admin, User, Guest ¹	X	X
Connectivity	Admin, User, Guest ¹	X	X
Control	Admin, User, Guest ¹	X	X
Robotics	Admin, User, Guest ¹	X	X
Power	Admin, User, Guest ¹	X	X
Cooling	Admin, User, Guest ¹	X	X

¹Guest can read status off the display but cannot click the relevant status button for more detail.

Toolbar

The toolbar contains icons that represent commonly used commands also available on the menus.

Figure 5. I/E Toolbar Button



I/E displays a table of the current contents of the I/E station. The information displayed by this button can also be displayed by selecting **Monitor**—> **I/E Station**. For an interpretation of the display, refer to [Monitoring I/E Station Status](#).

Figure 6. Import Toolbar Button



Import launches the import of cartridges, if the current library is a partition. An import can also be requested by selecting **Operations**—> **Import**. For information about this command, refer to [Importing Cartridges into Partitions](#).

Figure 7. Export Toolbar Button



Export launches the export of cartridges, if the current library is a partition. An export can also be requested by selecting **Operations**—> **Export**. For information about this command, refer to [Exporting Cartridges from Partitions](#).

Figure 8. Service Toolbar Button



Service launches the Service Wizard. This wizard can also be launched by selecting **Tools**—> **Service**. For information about this command, refer to [Troubleshooting](#).

Figure 9. Log Off Toolbar Button



Log Off logs off the current user, after confirming the logoff request. Another way you can log off is to select **Operations**—> **Logoff**. For information about this command, refer to [Logging off](#).

Reading the Library Information Panel

The library information panel occupies the central portion of the LMC display. It provides you with a great deal of status information at a single glance. The following information is dynamically displayed:

Figure 10. Library Information Panel

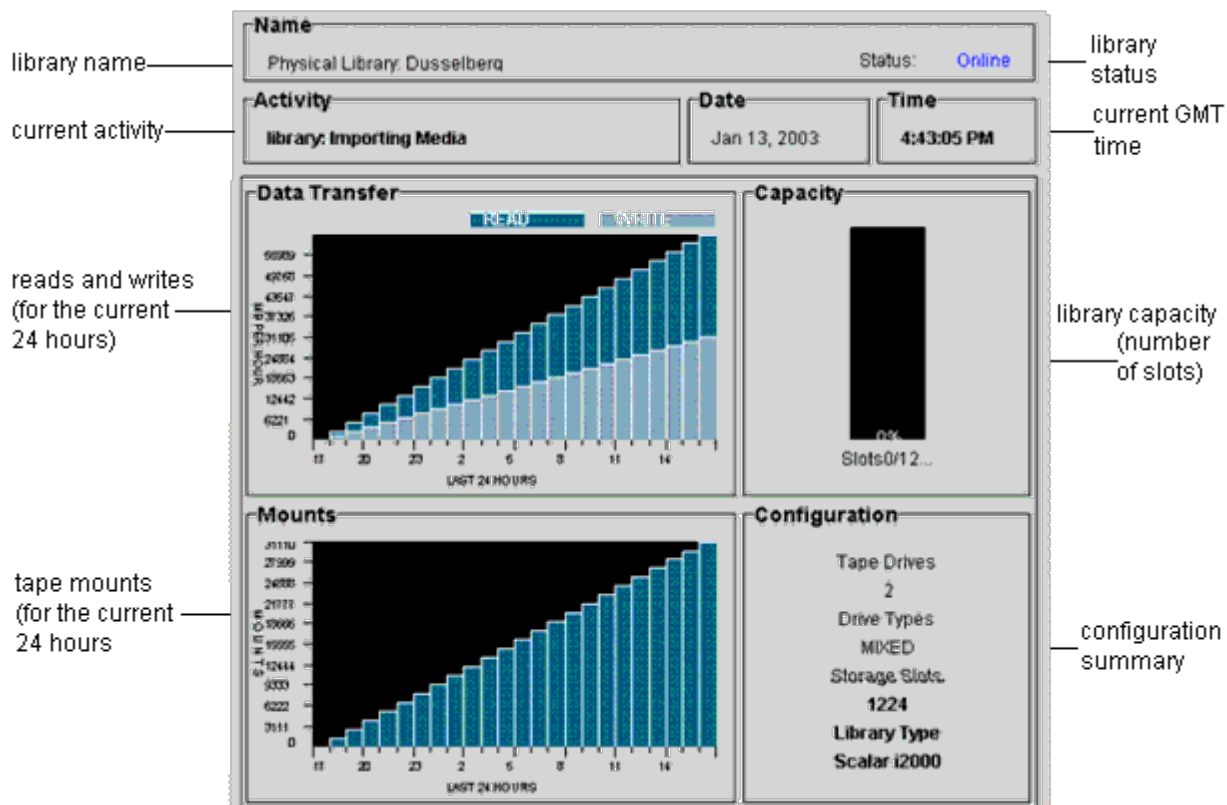

Table 6. Library Information Panel Data

Name	The name of the current library. This is the library that appears with a checkmark beside it in the View menu. The type of library is displayed first—physical or partition—followed by the name of the library.
Activity	The current activity for the current library.
Date	The current GMT date.
Time	The current GMT time.
Data Transfer	The bar graph compares the amount of data read and written for the past 24 hours. The units being reported will be displayed beside the graph.
Capacity	This graph displays the percentage of used media slots. The number of used media slots appears beneath the graph.
Mounts	The bar graph reports mount statistics for the past 24 hours. This information is updated every five minutes.
Configuration	Data points include: <ul style="list-style-type: none"> • Number of tape drives • Drive types: For example, LTO • Total number of storage slots • Library type (Dell PowerVault 160T)

System Status Buttons

Each of the six system status buttons includes an icon representing operational status of the library's subsystems. They are located at the bottom of the Library Management Console display.

Figure 11. System Status Buttons

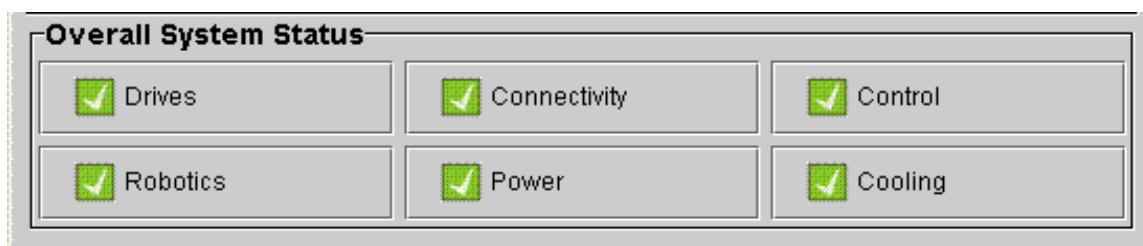

If any button shows a degraded or failed state, all information reported is for the physical library only. Select the button to view additional details. For more information on the status buttons, refer to the [Interpreting the System Status Buttons](#) description that follows.

System Status at a Glance

There are three ways to obtain information about the system subcomponents:

- [Interpreting the System Status Buttons](#)
- [Reading the Library Information Panel](#)
- [Monitoring Library Subsystems](#)

Interpreting the System Status Buttons

The overall system status panel is located below the library information panel. Each button represents one of the major subsystems of the physical library. Subsystem status is reported on the face of the button as **Good**, **Degraded**, or **Failed**.

Figure 12. Reported Statuses



To get more information about a reported status, select the appropriate button for a specific subsystem.

- If the state is **Good**, select the button to view a full status report for all relevant subcomponents.
- If the state is **Degraded** or **Failed**, select the button to view a **Current Problems** dialog box that lists components of the subsystem that are currently in a degraded or failed state. Follow the discussion in [Displaying Service Tickets](#).

[Table 7](#) shows the information available for each subsystem of a physical library reporting a state of **Good**. The **System**, **Control**, **Cooling**, and **Robotics** subsystems all return the **System Status** dialog box, which contains information about them. The **Drives** and **Connectivity** subsystems return dialog boxes specific to those subsystems. Partitions return only a subset of this information.

Table 7. Information About the Physical Library Obtained From the Status Buttons

Subsystem	General Component Information	Detailed Information
System Control Cooling Power		
System Name	[System ID]	[System Status]
Media Moves	[Robot number]	[Number of media moves within the history of the library]
Recovered Gets	[Robot number]	[Number of recovered gets within the history of the library]
Recovered Puts	[Robot number]	[Number of recovered puts within the history of the library]

Recovered Scans	[Robot number]	[Number of recovered scans within the history of the library]
MCB Status	[ID number]	Good, Degraded Failed
RCU Status	[ID number]	Good, Degraded Failed
Vertical Motion	N/A	[Meters traveled within the history of the library]
Horizontal Motion	N/A	[Meters traveled within the history of the library]
Drives		
	Drive ID	Drive type
		World Wide Name (WWN)
		Firmware revision
		Loaded, loading, unloaded or empty
		Location of the drive
		Serial number
		Number of loads
		Vendor
		Write protected
		Compression on or off
		Power on or off
		Date and time of error
		Error message for each drive listed
Connectivity		N/A

[Back to Contents Page](#)

[Back to Contents Page](#)

Working With Cartridges and Barcodes: Dell™ PowerVault™ 160T Tape Library User's Guide

- [Cartridge Handling Practice](#)
- [Write-Protecting Cartridges](#)
- [Installing Barcode Labels](#)
- [Using Cleaning Cartridges](#)
- [Managing Media](#)

The Library Management Console unifies and simplifies cartridge loading and unloading, importing and exporting, moving and inventory. The library expands to 1344 LTO media slots, and can accommodate Fibre LTO-1 or Fibre LTO-2 cartridges. Every partition in the library must contain at least one cleaning cartridge.

Cartridge Handling Practice

To ensure the longest possible life for all of your cartridges, follow these guidelines:

- Select a visible location to post procedures that describe proper media handling.
- Ensure that anyone who handles cartridges has been properly trained in all procedures.
- Do not drop or strike a cartridge. Excessive shock can damage the internal contents of the cartridge or the cartridge case itself, making that cartridge unusable.
- Do not expose cartridges to direct sunlight or sources of heat, including portable heaters and heating ducts.
- Do not stack cartridges more than five high.
- The operating temperature range for LTO cartridges is 10° to 35°C. The storage temperature range is 16° to 32°C in a dust-free environment with a relative humidity range between 20% and 80% (non-condensing).
- If a cartridge has been exposed to temperatures outside the ranges specified above, stabilize the cartridge at room temperature for the same amount of time it was exposed to extreme temperatures or 24 hours, whichever is less.
- Do not place cartridges near sources of electromagnetic energy or strong magnetic fields, such as computer monitors, electric motors, speakers, or x-ray equipment. Exposure to electromagnetic energy or magnetic fields can destroy data and the embedded servo code written on the media by the cartridge manufacturer, rendering the cartridge unusable.
- Place identification labels only in the designated slot on the cartridge.
- If you ship a cartridge, ship it in its original packing or something stronger than that.
- Do not insert a damaged cartridge into a drive.
- Do not touch the tape or tape leader.
- Do not degauss a cartridge that you intend to reuse.

Write-Protecting Cartridges

All cartridges have a write-protect switch to prevent accidental erasure or overwriting of data. Before loading a cartridge into the library, make sure the write-protect switch on the front of the cartridge is positioned correctly. Slide the switch to the right to write-protect the cartridge.

- For LTO cartridges, a small, orange padlock is visible when the cartridge is write-protected. See [Figure 1](#) for the location of the switch.

Slide the switch to the left to allow the library to write to the tape.

- The write-protect switch displays a black void when the cartridge permits overwriting and erasure.

Figure 1. Write-Protect Switch on an LTO-1 Cartridge

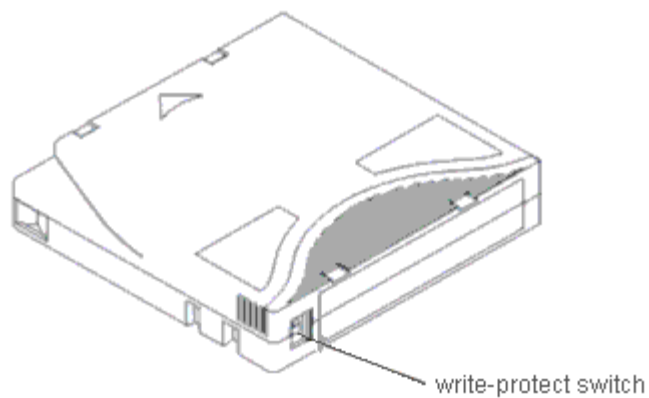

Installing Barcode Labels

You must apply all barcode labels to the front of the cartridge. Depending on the media type, barcode labels are either stickers that are adhered to the front of the tape cartridge or cutouts that you slide into an indentation on the front of the cartridge.

Peel off the label and place it on the cartridge. Verify that label is oriented so the numbers appear right-side up and above the barcode.

Figure 2. Applying the Barcode Label

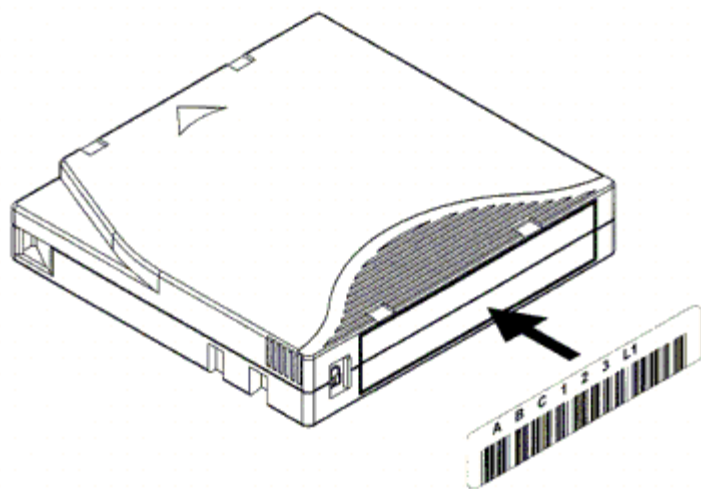

NOTICE: Be careful not to apply barcode labels upside down.

Using Cleaning Cartridges

Most tape drives require occasional cleaning. A cleaning cartridge cleans accumulated debris from the tape drive and the read/write head.

NOTICE: You must use a separate cleaning cartridge for each partition in the library.

Backup applications or archive software applications use different techniques to automate the process of cleaning drives. These tools specify cleaning cycles based on cycle counts of the drive, drive requests, or at a regularly scheduled interval.

The cleaning process itself requires certain considerations:

- Cleaning tapes must be labeled with a barcode. In some cases, specific labels have been established as industry

standard. For instance, the prefix "CLN" might be used to identify a cleaning tape. The library does not require a specific content to the label and accepts conventional tape labels.

- Insert a cleaning tape just as you do any other data tape. For example, the most common method is by means of the I/E station using host application control.
- Cleaning tapes often have limited lives that can be as few as 20 cycles. The controlling host application manages the number of uses of a cleaning tape. Errors can occur if a tape is inserted into a drive when the tape has already been used the maximum number of times.
- Export a cleaning tape just as any other data tape.
- The concept of physical and logical libraries must be considered when setting up cleaning procedures and methods. In general, cleaning cartridges must be treated in the same manner as data cartridges. Any physical cartridge, cleaning or data, can only exist in one logical library. There can be no sharing of cleaning cartridges between logical libraries.

Managing Media

The Library Management Console provides you with interfaces for:

- Importing and exporting cartridges
- Moving media from one storage location to another
- Loading and unloading drives
- Taking inventory

The following sections provide step-by-step instructions for performing these tasks.

Importing Cartridges into Partitions

When you first start using your library, open the door and manually insert as many cartridges as you plan to use directly into storage slots. The cartridges will not go back all the way if they are inserted incorrectly.

After your library is in operation, use the **Import** command to add cartridges without interrupting library operations. Place cartridges in the I/E station. The scanner automatically reads the barcodes on new cartridges.

1. Select a partition. To find out how to do so, refer to [Selecting a Library or Partition](#).

The system prompts you to take the partition offline, if it is not currently in that state.

2. Insert a data cartridge into an appropriate I/E station. You may insert multiple cartridges up to the maximum number of slots in your I/E station.

 **NOTE:** To see which I/E stations are associated with a particular partition, select **Monitor—> I/E station**.

3. Select **Operations—> Import** or use the **Import** toolbar button.

A table of cartridges in the I/E station is displayed.

The following information is displayed in the table:

Table 1. Information Displayed by Operations—> Import

Designation	Description
Media ID	Cartridge barcode.
Slot	The location of the cartridge. For help understanding the location designation, refer to Understanding Location Coordinates .
I/E station	The number of the module. For help understanding the location designation, refer to Understanding Location Coordinates .
Magazine	The number of the magazine (section) where the slot is located, numbered from the top down. For help understanding the location designation, refer to Understanding Location Coordinates .

Results	"Imported" or "Failed".
---------	-------------------------

4. Select **Import**.

The picker moves the cartridge automatically from the I/E station to the first available empty slot in that partition. You cannot manually specify the slot.

Exporting Cartridges from Partitions

Use the **Export** command to take cartridges out of the partition.

1. Select a partition. To find out how to do so, refer to [Selecting a Library or Partition](#).
2. Select **Operations—> Export** or use the **Export** toolbar button.

The system prompts you to take the partition offline, if it is not currently in that state.

A table of cartridges in the partition is displayed.

3. Select entries in the table to designate the cartridges for export.

The maximum number of cartridges available for export is displayed at the top of the table.

4. Select **OK** to continue.

All the designated cartridges are exported into I/E station slots selected automatically by the system. Items in the table are dynamically refreshed when the operation is complete.

Loading Drives

Use the **Drives** command to load drives with cartridges from the current partition.

1. Select a partition. To find out how, refer to [Selecting a Library or Partition](#).
2. Select **Operations—> Drives—> Load**.

A media table and a drive table are displayed in the dialog box.

3. Enter a media filter, if appropriate, into the **Media ID** text box.

The media filter performs a search for media IDs that match a particular pattern. For example, the media filter can be set to capture media IDs beginning with the string "J00" by entering "J00*" (without the quotes).

4. Select the data cartridge to load into the drive.

 **NOTE:** You can load only one cartridge at a time.

The parameters used to define a cartridge are media ID (barcode) and location. Location is defined as a series of coordinates representing the aisle, module, rack, section, column, and row where a cartridge is located. Refer to [Understanding Location Coordinates](#).

The upper portion of the table, labeled **Select Media** shows the full slots.

5. Select the destination drive to receive the media. The lower portion of the table, labeled **Select Drive** is populated with empty drives.

You can select only one drive at a time.

6. Select **OK** to load the data cartridge into the selected drive.

Unloading Drives

Use the **Unload** command to rewind the cartridge in the drive, eject it, and return it to storage.

 **NOTE:** Select a partition before you start unloading drives.

1. Select **Operations—> Drives—> Unload** .

A table of media is displayed in the **Unload Drives** dialog box.

2. Select the drive you want to unload. You can only unload one drive at a time.

Use the media filter to perform a search for media IDs that match or contain a particular pattern.

The parameters used to define a cartridge are media ID (barcode) and location. Location is defined as a series of coordinates representing the aisle, module, rack, section, column, and row where a cartridge is located. Refer to [Understanding Location Coordinates](#).

3. Select **OK** to rewind the data cartridge, unload it from the drive, and return it to storage.

Moving Media

The **Move Media** command allows you to move media from one location to another within a partition.



NOTE: Only one cartridge can be moved at a time.

1. Select a partition. To find out how, refer to [Selecting a Library or Partition](#).
2. Select **Operations—> Move Media** .

The **Move Media** dialog box is displayed. It consists of two tables, the **Select Source** table and the **Select Target** table.

When the dialog box first appears, the **Select Source** table is filled with full slots and the **Select Target** table is filled with empty slots.

You can filter the information in the **Select Source** table so that only a particular cartridge or a cartridge subgroup within a specified sublocation is displayed. Do the following as necessary:

- a. Type the barcode associated with a particular cartridge into the **Media ID** text box. Or use the media filter to perform a search for media IDs that match or contain a particular pattern. Select **Filter**.
 - b. Select the arrow next to the location coordinate boxes across the top of the **Select Source** dialog box. Then select an appropriate number. Then select **Show**.
3. In the **Select Source** table, select the media ID for the cartridge that you want to move. You may need to scroll down to see media IDs for cartridges that are in drives or I/E stations.
 4. In the **Select Target** table, select the destination for the media. You may need to scroll down to find appropriate drive or I/E station locations. You can limit the selection by using the sublocations listed in the **Drive Type** pull down: i/e station, storage, or drive.
 5. To complete the operation, select **OK**.

To close the dialog box without moving any media, select **Cancel**.

Inventory

The **Inventory** command causes the library to scan all storage locations, drives, and I/E stations. Inventory is completed automatically whenever the doors are shut. Inventories can be configured to occur whenever power is turned off and on, or by using the **Inventory** command. To enable automatic inventories, refer to [Setting up Policies for the Physical Library](#).

1. Log on as **Administrator**.
2. Select **Operations—> Inventory** .

The **Inventory** dialog box is displayed.

3. Click **OK**.

[Back to Contents Page](#)

[Back to Contents Page](#)

Configuring the Library: Dell™ PowerVault™ 160T Tape Library User's Guide

- [After Completing the Setup Wizard](#)
- [Selecting a Library or a Partition](#)
- [Working With Partitions](#)
- [Selecting a Mode](#)
- [Setting up Network Configuration](#)
- [Managing Connectivity](#)
- [Setting up Policies for the Physical Library](#)
- [Setting up Notification](#)
- [Specifying the Date and Time](#)
- [Enabling Licenses](#)
- [Configuring Devices](#)
- [FC Host](#)
- [SCSI Host](#)
- [Configuring E-mail Settings](#)

The library allows you to configure policies, e-mail, and notification mechanisms. It also allows you to configure drive, host, and media access in a partitioned environment. License keys can be upgraded at any time to provide increased storage or partition needs.

After Completing the Setup Wizard

1. Read this guide to familiarize yourself with all menus and tools from the Library Management Console.

 **NOTICE:** If you have configured more than one partition, use the I/E station to import cartridges.

2. Make decisions based on your configuration.
3. If your host(s) are connected through the management control blade run **FC Host** or **SCSI Host**, as appropriate, to allow the library to manage your media. Refer to [FC Host](#) or [SCSI Host](#).
4. If your host(s) are directly connected to drives, configure your third-party tape handling software.
5. Set up other users and grant them appropriate privileges. For instructions, refer to [Creating User Accounts](#).
6. Follow the instructions in [Configuring E-mail Settings](#).

 **NOTE:** If you configured the e-mail settings in the course of installing a remote client, you do not need to configure them again.

7. Set up notifications. For instructions, refer to [Setting up Notification](#).
8. Install (and launch) a remote client so you can use all library features. For instructions, refer to [Installing a Remote Client](#).
 - Updating software requires a remote client connection.
 - Saving or printing reports requires a remote client connection.

Selecting a Library or Partition

1. Select the **View** menu.
2. Select the name of the library or partition to view statistics or to operate.
 - The physical library is listed above the dividing line
 - Partitions are listed below the dividing line

Information about the selected library is displayed in the library information panel.

Working with Partitions

A partition is an abstraction of a single underlying physical library that presents the appearance of multiple, separate libraries for purposes of file management, access by multiple users, or dedication to a specific host application. You can choose to run one software application in one partition, for example, and a different software application in a second partition. Partitions are also known as logical libraries.

Each partition contains the following components of the physical library:

- Medium changer—the robotic assembly that shuttles removable media throughout the system. Also known as the media transport element.
- I/E station—a magazine containing slots that allow removable media to be introduced into or removed from the physical library. The type of media determines the number of slots. For example, in an LTO magazine there are six slots.
- Storage segment—a static column location within a section of the physical library rack that holds removable media. For more about location coordinates, refer to [Understanding Location Coordinates](#).
- Drive segment—the read/write device for removable media. Also called the data transport element.

A partition consists of, at minimum, one storage segment and one drive. Neither the storage segment nor the drive can be shared with another partition. Each partition is specific to a media type (for example, LTO-1, LTO-2) and a drive interface (for example, Fibre). The magazines in an I/E station can be shared by up to four partitions. Only components belonging to the same media class can be assigned to a partition. The maximum number of partitions is limited to the lesser of the number of drives available in the physical library (assuming there are at least as many storage slots), or 16.

Configuration controls such as **FC Host** and **SCSI Host** provide the means to permit host access to a particular partition. Multiple hosts can share a single partition or a partition can be restricted to one exclusive host.

The host applications control access to elements within the shared partition. When the hosts are connected directly to the drives, this is true exclusively. When the hosts connect through the MCB or an I/O blade, the library also has access to partition elements, such as drives, media, etc. Multiple applications may each have a partition assigned to them. Each application uses its partition as if it were a dedicated physical library.

Creating Partitions

1. Log on as **Administrator**.
2. If you are not already working from the physical library, select it from the **View** menu. Refer to [Selecting a Library or Partition](#).
3. Select **Setup**—> **Partitions**.



NOTE: Be sure that you have adequately planned for the number of partitions that you want to configure.

The **Partitions** dialog box is displayed.

Your library comes with one partition already configured. You must delete the existing partition before you can create others.



NOTICE: Whenever an existing partition is deleted, extreme care must be taken to recreate a partition that includes the same media type, interface, I/E station magazines, and a host at the same LUN, for the host application to have access to previously written data.

4. Select the existing partition, and then select **Delete**.

If the partition is online, you will be asked whether or not it can be taken offline. You must answer **Yes** to continue the deletion process.

The selected partition is deleted and the **Partitions** dialog box is refreshed. The **Create** button becomes available.

5. Select **Create**. The **Choose Creation Mode** dialog box is displayed.
6. Select either **Automatic** or **Manual**.

Automatic partitions are created according to the following system defaults:

- Media type checking is enabled
- The slots for the specified media type are equally divided among the number of libraries that you have specified for a particular media type.

If you select **Automatic**, the **Automatic Creation** dialog box is displayed. Proceed to [Creating Partitions Using Automatic Mode](#).

If you select **Manual**, the **Choose Partition Properties** dialog box is displayed. Proceed to [Creating Partitions Using Manual Mode](#).

Creating Partitions using Automatic Mode

1. After completing the steps in [Creating Partitions](#), enter the number of partitions to create in the column labeled **Partitions**.

The maximum number of partitions that you can enter is determined by the number of partitions you are licensed to create. Partitioning licenses are available for either one partition or 16 partitions. Refer to [Enabling Licenses](#).

Typically, each partition should have at least one dedicated drive. For more information about partitions, refer to [Working with Partitions](#).

2. Select **Finish** to create the libraries and exit the automatic partition creation process.

Creating Partitions Using Manual Mode

1. After completing the steps in [Creating Partitions](#), enter defining parameters into the **Choose Partition Properties** dialog box for the library you are creating.
 - Type a name into the **Name** box.
 - Select a media type from the **Media Type** drop-down box.

 **NOTE:** The product ID is Scalar i2000.

2. Select **Next** to proceed.

The **Choose Policy Settings** dialog box is displayed.

3. Media type checking is enabled by default. When cartridges are imported or mounted, the system automatically checks the media type.
 - If you do not want the media type to be checked automatically when cartridges are inserted into the library, select **Disable**.
 - If you want the media type to be checked automatically when cartridges are inserted into the library, leave the selection at **Enable**.

4. Select **Next** to proceed.

The **Choose Resource Quantities** dialog box is displayed.

5. Enter the number of elements to include in the partition by specifying three parameters:
 - Number of drives
 - Number of storage slots
 - Number of I/E magazines

6. Select **Next**.

The **Summary Information** dialog box is displayed.

7. To create the partition, select **Create**.

The **Partitions - Completed** dialog box is displayed.

8. Review the information to make certain it is correct.

The partition license on the library is initially configured to allow two partitions. To create a second partition, repeat the steps of the procedure [Creating Partitions Using Automatic Mode](#). After you complete [Step 4](#), the **Choose Resource Quantities** dialog box displays. This time it looks a little different.

The system has adjusted the number of drives, storage slots, and I/E magazines available based on your previous partition.

Deleting Partitions

 **NOTICE:** Whenever an existing partition is deleted, extreme care must be taken to recreate a partition that includes the same media type, interface, I/E station magazines, and a host at the same LUN, for the host application to have access to previously written data.

1. Log on as **Administrator**.
2. If you are not already working from the physical library, select it from the **View** menu. Refer to [Selecting a Library or Partition](#).

3. Select **Setup—> Partitions**.

The **Partitions** dialog box is displayed.

4. Select the name of the partition you want to delete.

 **NOTE:** Only one partition can be deleted at a time.

5. Select **Delete**.
 - a. If the partition is online, you will be asked whether or not it can be taken offline. You must answer **Yes** to continue the deletion process. If you answer **Yes**, the partition is taken offline.
 - b. Select **Delete**.

The selected partition has been deleted. Repeat the process to delete another partition, or select **Close**.

Selecting a Mode

When you issue a command that requires the library to undergo a change in its operational status, you are always asked to confirm the change first. To find out which commands require the library to be taken offline, refer to [Table 4](#).

1. Select **Operations—> Change Mode**.

The **Change Library Mode** dialog box is displayed.

2. Do one of the following:
 - o Selecting **Online** sets the library within the current view to the normal operating condition. In this mode the robotics are enabled and all host commands are processed.
 - o Selecting **Offline** allows you to take the current library to an offline state. Host commands are not processed. If the library is a physical library with partitions, all partitions are also taken offline. If the library is a partition, other partitions are not affected.
 - o Selecting **Shutdown** allows the operator to properly shut down the library. All active commands from the host are completed, but no new commands are accepted. This option is available only when a physical library has been selected and you are working from the touch screen. All associated partitions are also shut down. After the front panel goes dark, push the **Power** button to turn the library off. For the location of the **Power** button, refer to [Indicator Panel](#).

Setting up Network Configuration

 **NOTE:** You can configure the network only from the touch screen.

Make certain that your library is attached to the network before you use the **Network Configuration** command. You must fully understand all network issues before you change the network configuration for a working system:

1. Log on as **Administrator**.
2. Select the physical library. To find out how to select a particular library, refer to [Selecting a Library or Partition](#).
3. Select **Setup—> Network Configuration**.

The **Network Configuration** dialog box is displayed.

4. Make entries or changes in the text boxes, as appropriate:
 - o If you have DHCP enabled on your network, select **Enable** and enter the DHCP server name in the **Library Name** box.
 - o If you do not have DHCP enabled on your network, select **Disable** and enter the IP Address of the library in the **IP Address** box.
 - o Enter the subnet mask and the IP address of the default gateway for your portion of the Ethernet network in the **Subnet Mask** and **Default Gateway** boxes, respectively.

If necessary, consult with your network administrator to verify this information.

5. Select **OK**.



NOTE: After you change the network configuration, the touch screen display is automatically restarted. It will take a few minutes for the LMC to be restored to the touch screen.

Managing Connectivity

The **Connectivity** command on the **Setup** menu allows you to configure parameters for FC (Fibre Channel) connectivity. You can view the settings for SCSI connectivity.

1. Log on as **Administrator**.
2. Select the physical library. To find out how to select a particular library, refer to [Selecting a Library or Partition](#).
3. Select **Connectivity—> Setup**.

The **Connectivity** dialog box is displayed.

4. Select a SCSI channel or a Fibre Channel, and then select **Configure**.

If you select a SCSI channel, the **SCSI Channel Parameters** dialog box is displayed. If you select a Fibre Channel, the **Fibre Channel Parameters** dialog box is displayed. You cannot configure settings on the **SCSI Channel Parameters** dialog box.

5. On the **Fibre Channel Parameters** dialog box, you can configure two settings for the MCB connection and all settings for I/O blade connections. Selecting **Soft** acts as a toggle, checking and clearing the box. If the box is unchecked, you can select a hard loop ID from the drop down list by specifying a number within the range of 0 to 125. Some operating systems require hard ID settings. Consult your service representative before making changes to this setting.
6. The default connection option mode is **Loop**. Other options include **Loop Preferred**, **Point to Point**, and **Point to Point Preferred**. Consult your service representative before making changes to this setting.
7. When you have made configuration choices, click **OK**.

You are prompted to reset the channel. If you select **Yes**, the channel resets immediately. If you select **No**, you must reset the channel manually, using the **Reset** button at the bottom of the dialog box before exiting the procedure.

If you do not reset the channel, the next time you open the **Fibre Channel Parameters** dialog box, your pending changes will be displayed in a sidebar.

Setting up Policies for the Physical Library

The **Physical Library** command allows you to configure various operating modes, including:

- Enable or disable **Automatic Teach**

Specify whether or not the robotic assembly should be automatically calibrated and configured, if necessary, each time the power cycles off and on.

- Enable or disable **Automatic Inventory**

Specify whether or not the library should scan inventory automatically each time the power cycles off and on.

1. Log on as **Administrator**.
2. Select the physical library. To find out how to select a particular library, refer to [Selecting a Library or Partition](#).
3. Select **Setup—> Physical Library**.

The **Physical Library** dialog box is displayed.

4. Select **Enable** in the **Automatic Teach** area to schedule automatic calibration and configuration of the robotic assembly upon power up.

Automatic Teach is disabled by default.

5. Select **Enable** in the **Automatic Inventory** area to schedule automatic inventories of library contents upon power-up.

Automatic Inventory is disabled by default.

6. When you have finished configuring the parameters, select **OK**.
-

Setting up Notification

The **Notification** command allows you to send e-mail to specific individuals whenever certain conditions occur.

1. Log on as **Administrator**.
2. If you are not already working from the physical library, select it from the **View** menu. Refer to [Selecting a Library or Partition](#).
3. If you have not already configured an e-mail server, complete the steps in [Configuring E-mail Settings](#) before proceeding.
4. Select **Setup—> Notification**.

The **Notification** dialog box is displayed.

The default notification address for Severity 1 issues is **support@us.dell.com**.

5. To delete an e-mail address, select the address in this dialog box, and then select **Delete**.
6. Select **Create** to enter an e-mail address. The **New Email Notification** dialog box is displayed.
7. Type in the e-mail address in the blank box after the words **Email Address**.

Do not enter multiple addresses into this box. To associate more than one e-mail address with events of a particular severity, repeat the **Create** process.

8. Select the severity level that will be reported.

The severity levels are numbered from 1 to 5, with 5 being the least severe. If you specify level 3, notifications are not sent for events that are associated with levels 1, 2, 4, or 5. Level 5 represents a return to "Good" from "Degraded" or "Failed."

Level	Meaning
1	Failed
2	Degraded
3	Warning
4	Information

5	Good
---	------

You can select multiple severity levels by holding down shift and clicking each choice.

- o Repeat Step 5 to Step 7 as often as necessary.
- o Select **OK** on the **New Email Notification** dialog box.
- o When your specifications have been completely entered, select **OK** on the **Notification** dialog box.

Specifying the Date and Time

The **Date and Time** command is used to set system time (if you are not using the **Setup Wizard** to configure your system) or to reset system time.

1. Log on as **Administrator**.
2. If you are not already working from the physical library, select it from the **View** menu. Refer to [Selecting a Library or Partition](#).
3. Select **Setup—> Date and Time**. The **Date and Time** dialog box is displayed.
4. In the **Date and Time** dialog box, set the following parameters:
 - o Use the pull-down menus to set the month, date, and year.
 - o Use the pull-down menus to set the hour, minute, and—because the clock is not a 24 hour clock—whether the time is am or pm.

 **NOTE:** Use Greenwich Mean Time.

5. Select **OK**.

Enabling Licenses

The **Licenses** command is used to enable specific features:

- Scalability

You can scale from 100 to 1344 LTO cartridges and up to 48 LTO drives by simply using a new software key. These numbers vary by drive type.

- Partitioning

The number of partitions is limited to the number of drives available in the physical library (assuming there are at least as many storage slots), or 16.

1. Log on as **Administrator**.
2. If you are not already working from the physical library, select it from the **View** menu. Refer to [Selecting a Library or Partition](#).
3. Select **Setup—> Licenses**.
The **Licenses** dialog box is displayed.
Licensed features are shown with the status and expiration date for each feature.
4. Enter the appropriate license key into the text box after **Enter License Key**.
5. Select **OK**.

Configuring Devices

The **Setup—> Device** command allows you to change the way system components are mapped.

The **IDs** command is available from the physical library. Use this to set the Loop ID of a drive. All hosts viewing the drive will see the same Loop ID associated with the drive.

FC Host and **SCSI Host** are available from the partition. Use them to configure access to partitions on a per-host basis. If you have connected your host to either the FC port or the SCSI port on the MCB, you must map the appropriate partitions with either **FC Host** or **SCSI Host**. If you have connected your hosts directly to the drives, use the third-party software of your choice to manage your media from the host itself.

If you have not otherwise restricted access, **FC Host** has full control of all LUNs on all FC and SCSI channels. Each FC host can be configured to access a maximum of 255 LUNs, up to an overall system total of 2048.

If you have not otherwise restricted access, **SCSI Host** has full control of all LUNs on all FC and SCSI channels, up to an overall system total of 2048. SCSI hosts can configure access at the LUN-level for an overall system total of up to 2048 LUNs.

Setting Device IDs

From a partition you can change the Loop ID for a Fibre-attached drive. For example, the default Loop ID for a drive that you are installing may conflict with the assigned Loop ID of an existing drive. You may be using an application that expects to communicate with a device at a specific Loop ID, but that ID may already have been configured for use in another partition. Use the **IDs** command on the **Device** submenu to correct these situations.

1. Log on as **Administrator**.
2. If you are not already working from a partition, select it from the **View** menu. Refer to [Selecting a Library or Partition](#).
3. Select **Setup**—> **Device**—> **IDs**.

The **Device IDs** dialog box is displayed.

Figure 1. Device IDs Dialog Box

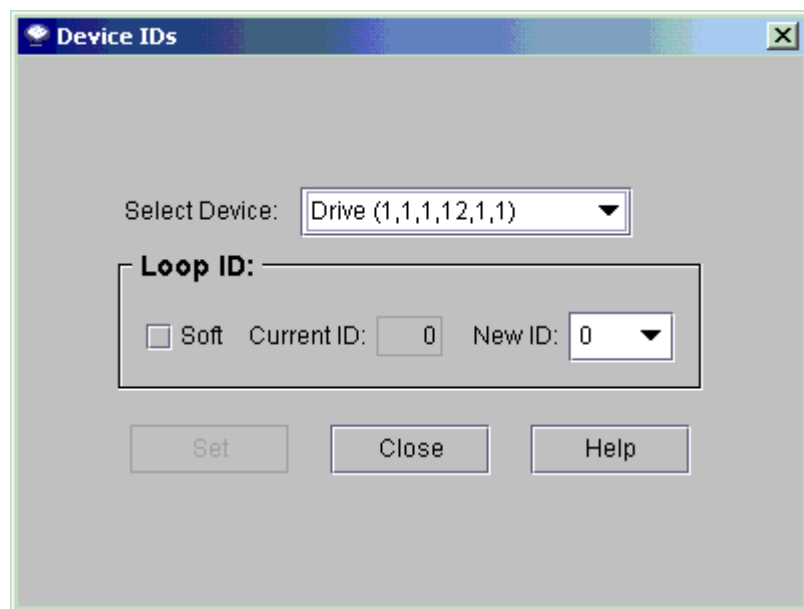

The drive shown in [Figure 1](#) is in the topmost of the twelve drive bays in a control module. See [Figure 2](#). To better understand location coordinates, refer to [Understanding Location Coordinates](#).

Figure 2. Drive Position (1,1,1,12,1,1)

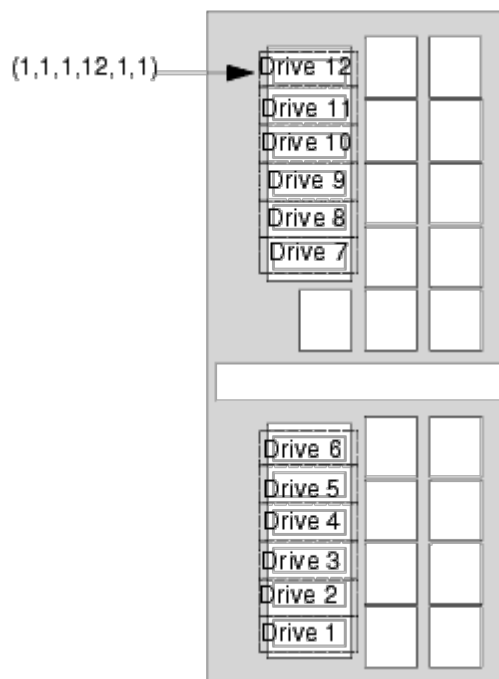

4. To specify a particular ID for an FC drive, select a new FC ID number by using the arrow beside the **New ID** box. or select the check box in front of **Soft** to automatically assign an FC ID.
5. Select **Set**.

FC Host

The **FC Host** feature allows an FC-attached host to create a virtual private remapping of available LUNs.

 **NOTE:** Use **FC Host** to map partitions when a Fibre Channel host is connected to the MCB.

Depending upon host operating system constraints, it may be necessary to reboot or reconfigure a host as a result of device map changes resulting from using **FC Host**.

1. Log on as **Administrator**.
2. If you are not already working from the physical library, select it from the **View** menu. Refer to [Selecting a Library or Partition](#).
3. Select **Setup**—> **Device**—> **Access**—> **FC Host**.

A dialog box is displayed. Long strings may not be visible at first, but the **FC Host** dialog box is sizeable.

 **NOTE:** If you do not have an Fibre Channel host connected to the library, the **FC Host** command is not available.

The host's port, blade, and WWN (World Wide Name) are displayed.

4. Select an FC host to configure.
5. With the host selected, select **LUN Mapping**.

The dialog box in [Figure 3](#) is displayed. In [Figure 3](#) you can see the default view. Compare the default view to the **Show Details** view displayed in [Figure 5](#). In the **Show Details** view, the name, product ID, vendor ID, and serial number of the logical library are shown in the **Device** column. In the default view, only the names of available partitions are shown in the **Device** column. LUN spaces from 0-255 are always available in the **LUN/Device** column, no matter what view you have chosen.

In [Figure 3](#), the partitions (devices) that have not yet been manually reassigned to a new map position appear in heavy black type in the **Device** column. Partitions are treated by the system as devices. You must drag a partition to the **LUN/Device** column for the Library Management Console to manage it and its media. In this example, the control LUN has already been remapped as shown in heavy black type in the **LUN/Device** column.

In [Figure 4](#) all devices have been manually mapped. The new map locations appear in heavy black type in the **LUN/Device** column. The previous (default) device map position of a remapped device is shown in gray type in the **Device** column.

Figure 3. FC Host LUN Mapping Dialog Box (Default View)

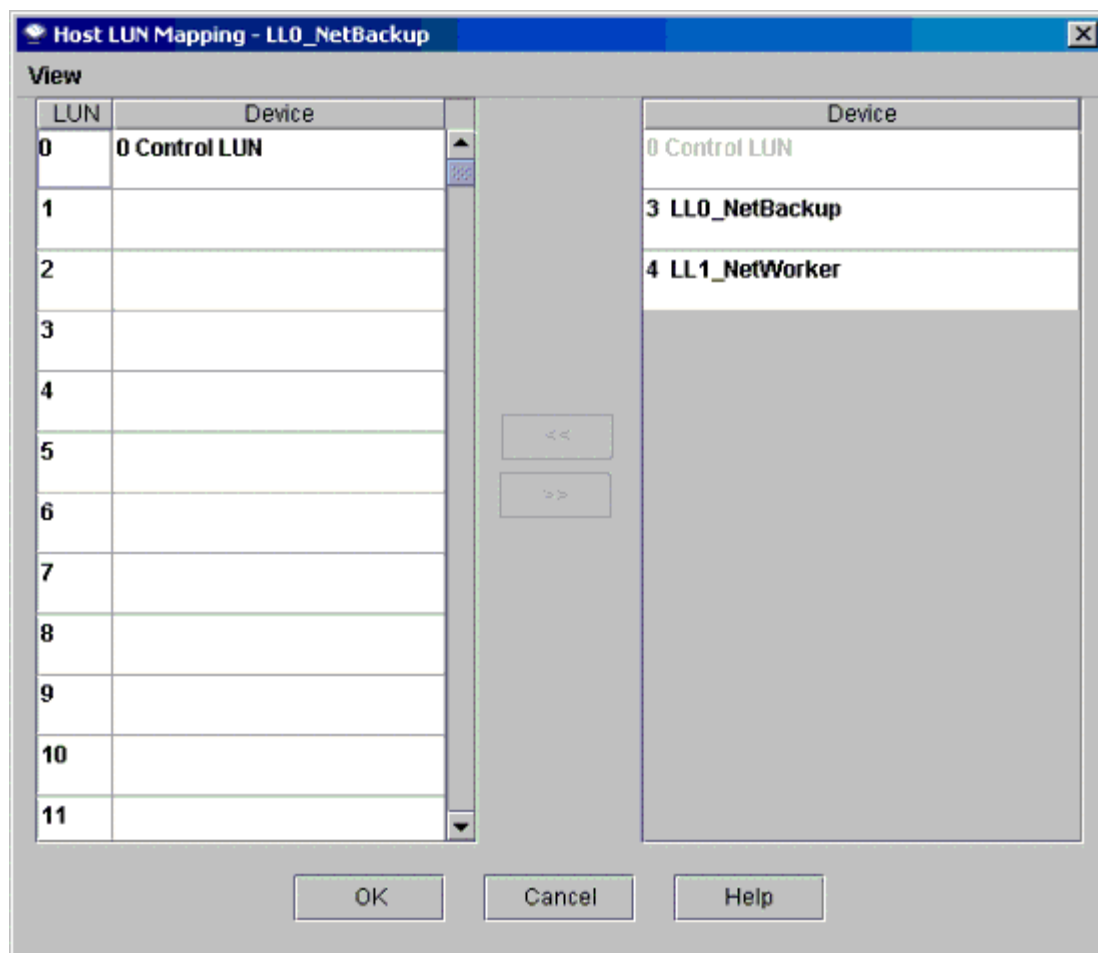

6. Drag and drop the devices from the **Device** column to the appropriate LUN assignment in the **LUN/Device** column.
7. Select **OK** to save the mapping.

The **FC Host** map is automatically saved as part of the configuration.

Figure 4. FC Host Devices Mapped (Default View)

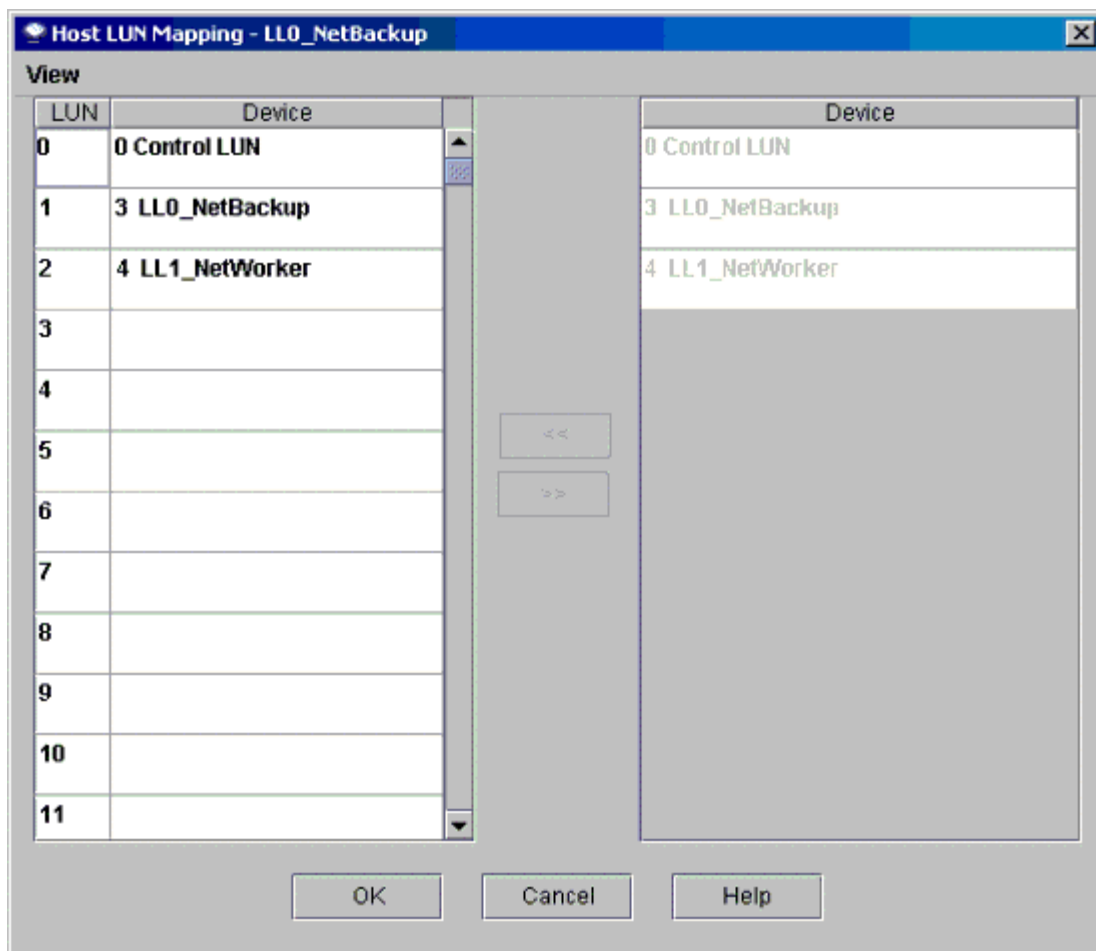
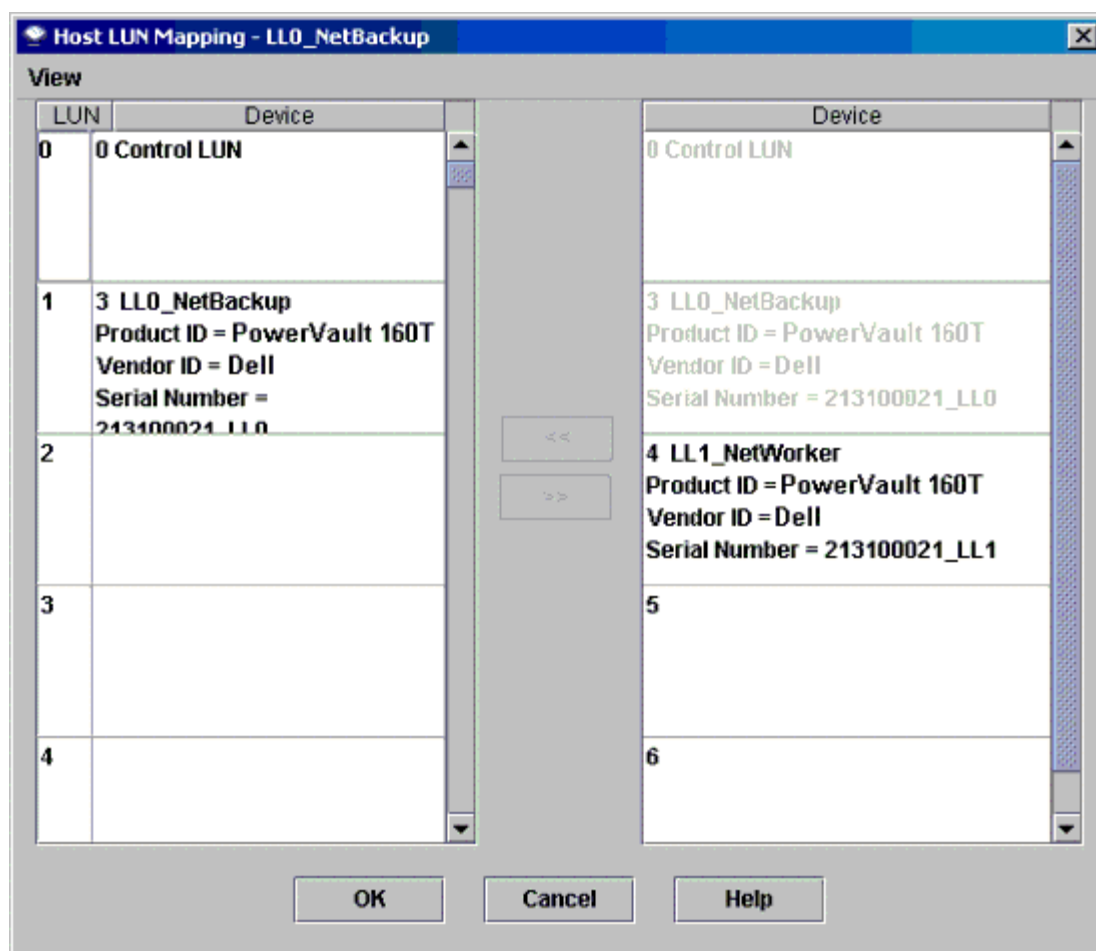

Figure 5. FC Host LUN Mapping Dialog Box (Show Details View)



When a device has been mapped, it is still listed, though unavailable, in the **Device** column.

- In [Figure 4](#) the LUNs are not currently available for mapping, because they have already been mapped into the **LUN/Device** column. The device that was formerly found at assigned LUN 3 is now found at assigned LUN 1. Drag it back into the **Device** column to make it available for re-mapping.

Setting the View for the FC Host Device Column

- Select the **View** menu on the **FC Host** dialog box. If you want to see product details, select the box in front of **Show Details**. If you want to see only the names of the devices available for mapping, select **Show Details** again to toggle the display back to the default.

Modifying FC Host settings

FC hosts can be reconfigured without powering down the system.

1. With the host selected in the **FC Host** dialog box, select **Modify**.

The **Host Configuration** dialog box is displayed.

2. Change the **Name**, **Type**, or **Port**. You can not change the WWN.
3. Select the **OK** button to keep the changes you made.

SCSI Host

The Library Management Console **SCSI Host** feature allows a SCSI-attached host to create a virtual private remapping of available LUNs.

NOTE: Use **SCSI Host** to map partitions when a SCSI host is connected to the MCB.

Before you map devices using **SCSI Host**, you must configure system components appropriately.

1. Log on as **Administrator**.
2. If you are not already working from the physical library, select it from the **View** menu. Refer to [Selecting a Library or Partition](#).
3. Select **Setup—> Device—> Access—> SCSI Host**.

The **SCSI Host** dialog box is displayed.

4. Select a SCSI port to configure.
5. With the port selected, select **LUN Mapping**.

The **SCSI Host Map** dialog box is displayed.

Figure 6. SCSI Host Map Dialog Box (Default View)

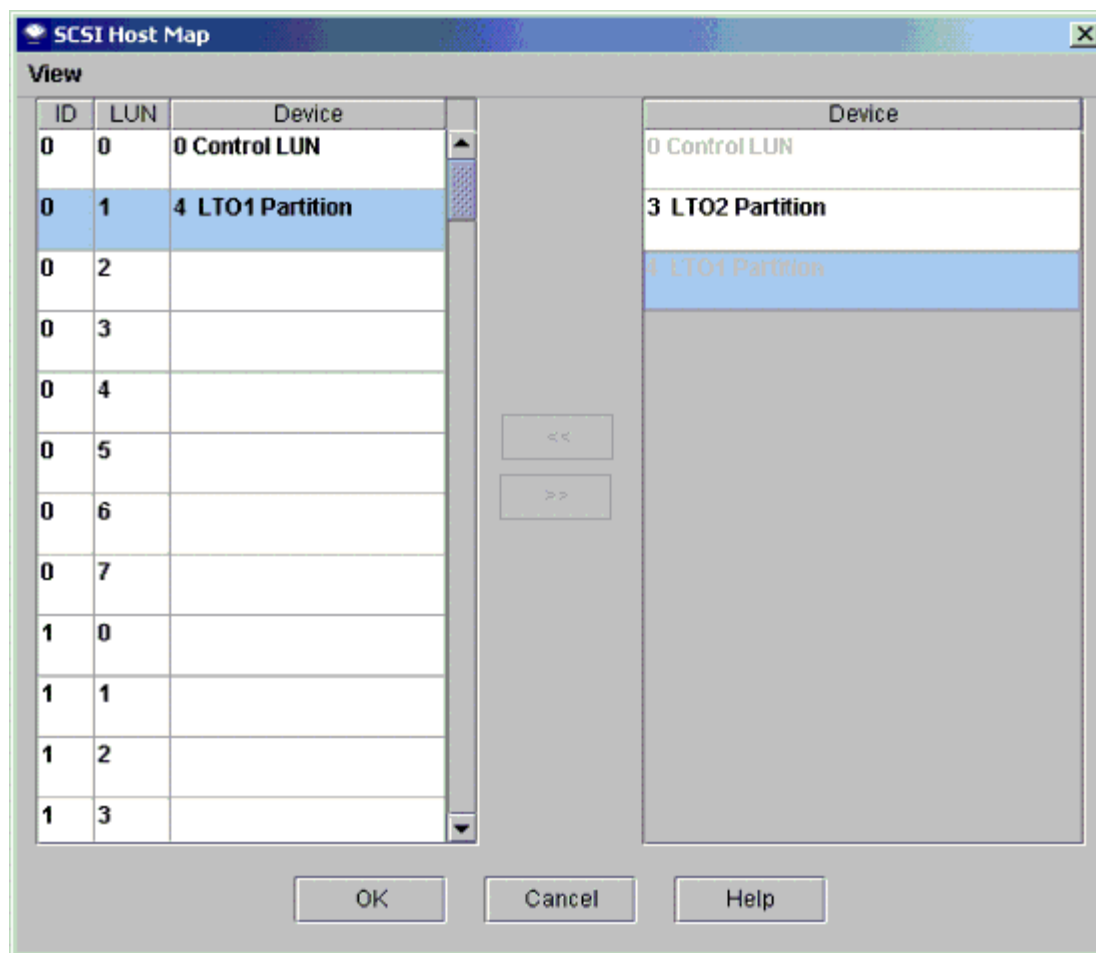

6. Drag the partitions that you want the SCSI host to manage from the **Device** column to the **ID/LUN/Device** column.

In [Figure 6](#) you can see the default view. In the default view, only partition names and the SCSI ID of the host connection are shown. Compare this view to the **Show Details** view displayed in [Figure 7](#). In the **Show Details** view, partition name, product ID, vendor ID, serial number, and the SCSI ID of the host connection are shown.

In [Figure 8](#) all devices have been manually mapped. The new map locations appear in heavy black type in the **ID/LUN/Device** column. The previous (default) device map position of a mapped device is shown in gray type in the **Device** column. In [Figure 6](#), the partition (device) that has not yet been manually reassigned to a new map position appears in heavy black type in the **Device** column. The control LUN and the "LTO1" partition have been mapped in [Figure 6](#).

7. Drag and drop the devices from the **Device** column to the appropriate LUN assignment in the **ID/LUN/Device** column.

The right column of the SCSI host map dialog box, labeled **Device**, lists all available devices. The **ID/LUN/Device** column on the left provides map space for IDs 0-15 associated with the selected SCSI Channel, and LUNs 0-7 associated with each ID. Drag and drop devices from the **Device** column into the boxes associated with particular LUN assignments in the **ID/LUN/Device** column.

Figure 7. SCSI Host Map (Show Details View)

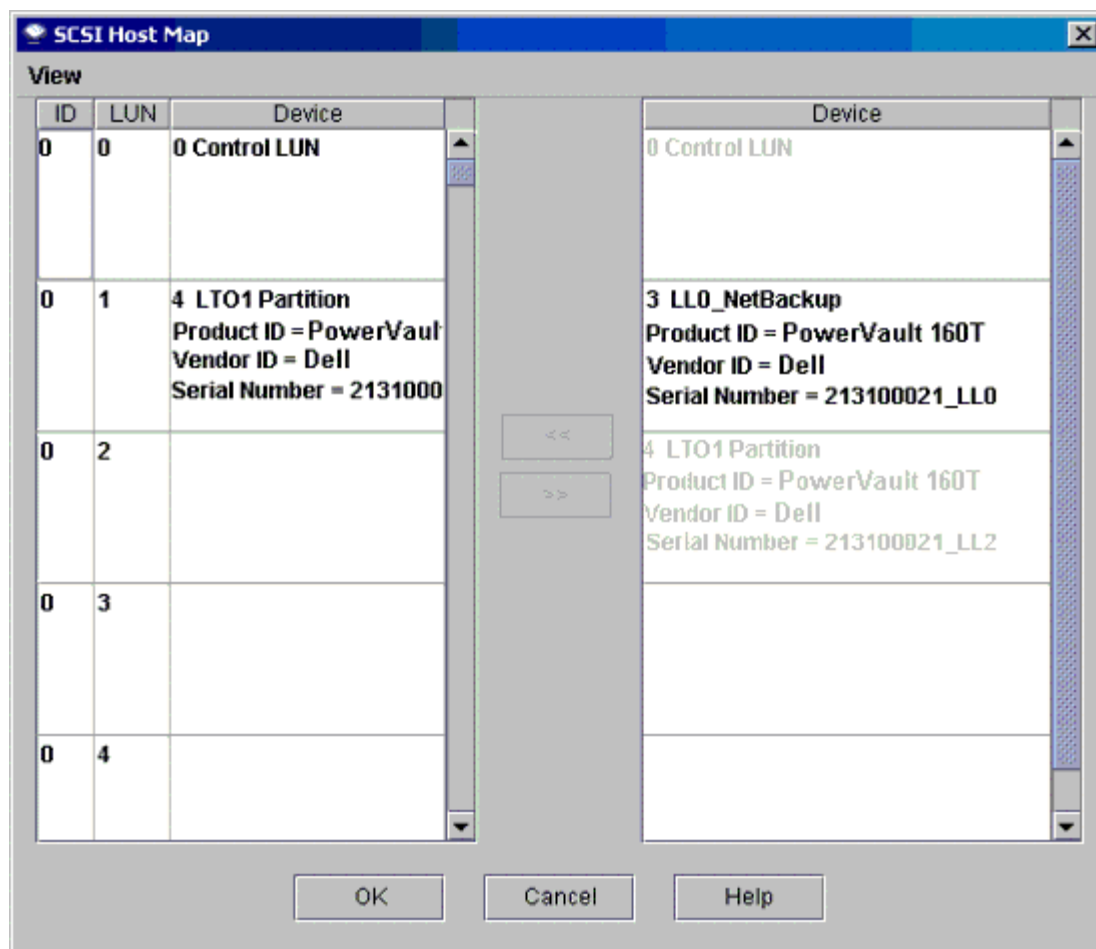

8. Select **OK** to save mapping.

The **SCSI Host** map is automatically saved as part of the configuration.

Modifying SCSI Host Mapping

When a device has been mapped, it is still listed, though unavailable, in the **Device** column.

- In [Figure 8](#) some LUNs are not currently available for mapping, because they have been mapped into the **ID/LUN/Device** column already. Drag them back into the **Device** column to make them available for re-mapping.

Setting the View for the SCSI Host Device Column

- Select the **View** menu on the **SCSI Host** dialog box. If you want to see product details, select the box in front of **Show Details**. If you want to see only the names of the devices available for mapping, select **Show Details** again to toggle the display back to the default.

Figure 8. SCSI Host Devices Mapped

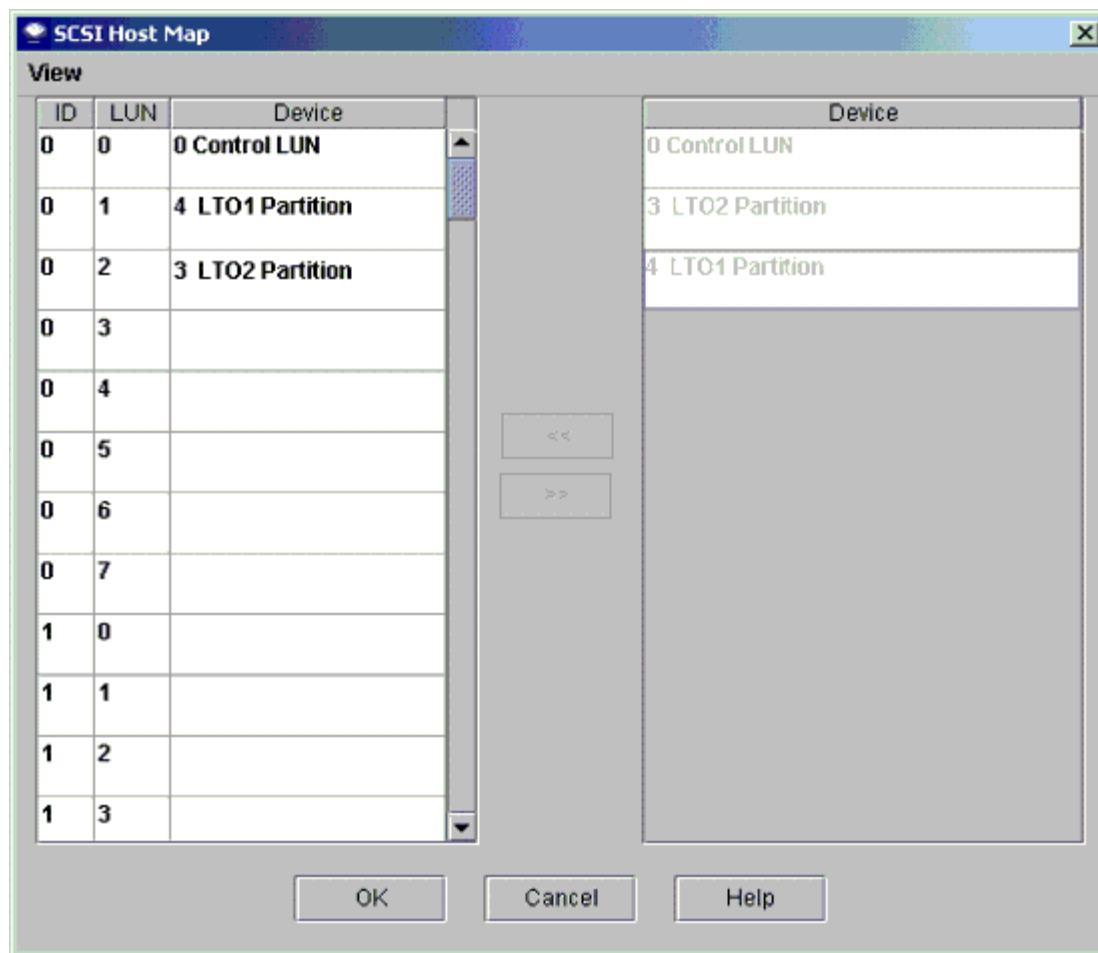

Configuring E-mail Settings

The e-mail settings are used by the notification and tools features. If a problem occurs in the library, you can have an e-mail automatically sent to Dell Support or you can have problem details sent to yourself or to others.

1. Select **Setup—> Email Configuration**.

The **Email configuration** dialog box is displayed.

2. Enter the following information into the **Email Configuration Settings** dialog box:

- SMTP Server (for example, 192.16.68.2)

➔ **NOTICE:** The SMTP server must be identified by its IP address.

- Account (for example, Jay.User)

➔ **NOTICE:** The account specified must be a valid account at the named SMTP server.

- Password (for example, passw0rd)

➔ **NOTICE:** The password specified must be valid for the specified account at the named SMTP server.

- Sender Address (for example, PowerVault160T@MyCompany.com)

3. Select **OK**.

[Back to Contents Page](#)

[Back to Contents Page](#)

Running Your Library: Dell™ PowerVault™ 160T Tape Library User's Guide

- [Logging on Remotely](#)
 - [Logging Off](#)
 - [Working With User Accounts](#)
 - [Understanding Location Coordinates](#)
-

When you log on as administrator, you are responsible for setting up and managing users, managing partitions, managing the physical library, specifying notification policies, updating software, configuring access, setting the date and time, and importing, exporting, and moving media.

Logging on Remotely

If the library is already configured, you are ready to perform library management tasks. If you are standing in front of the library, refer to [Logging on Locally](#).

1. Go to **Start—> Programs—> Dell—> Client**.

 **NOTE:** If you did not accept the defaults when you installed the client, you must navigate to the location you chose.

The **Connect to SNC Manager Server** dialog box is displayed.

2. Enter the IP address of the library.
3. Select **OK**.

The Library Management Console (LMC) and the **PowerVault 160T Logon** dialog box are displayed.

4. Enter your username and password.
 5. Select **OK**.
 6. If the library is already configured, you are ready to perform library management tasks.
Initial configuration of the library requires the use of the local interface. Refer to [Logging on Locally](#) and then to [Running the Setup Wizard](#).
-

Logging off

Log off after you have completed your management session.

Select **Operations—> Log Off**.

You can also log off by selecting the [Log Off toolbar button](#).

If you are managing the library from the touch screen and select the **Log Off** command, you will see the **Log On** display. To return to library management, simply log on again.

If you are managing the library from a remote client and select the **Log Off** command. The LMC display will close. To log back on after this, follow the procedure in [Logging on Remotely](#). For information about setting up a remote client, refer to [Installing a Remote Client](#).

Working With User Accounts

There are three user privilege levels: guest, user, and administrator. **Guests** see only the Library Management Console main screen. **Users** are allowed to operate a partition, but cannot run diagnostic tools (which require access to the physical library), and **administrator** users are allowed access to the entire physical library and all of its partitions. For a summary of user privileges defined by physical library, partition, and command menu, refer to [Table 4](#).

Creating User Accounts

1. Log on as administrator.
2. If you are not already working from the physical library, select it from the **View** menu. Refer to [Selecting a Library or Partition](#).

3. Select **Setup—> Users**.

The **Users** dialog box appears.

4. To create a user account, select **Create**. The **User Account Type** dialog box is displayed.
5. Enter the new user name and password.
6. Retype the password.
7. Select a privilege level.

The choices are **Administrator** or **User**.

For a list of commands available to the **Administrator** and those available to the **User**, refer to [Table 4](#).

- o If you select the **User** privilege level, the **Assign Partitions** dialog box appears. Proceed to [Step 8](#).
- o If you select the **Administrator** privilege level, proceed to [Step 9](#).

8. Select the library or libraries to which the user should have access, or select **Select All** to assign access to all listed libraries.



NOTICE: To maintain security, the administrator password should be changed during the first session where the default admin/password account is used.

9. Select **Finish** to register library access decisions, or **Cancel** to exit without making changes.

Whenever the **Back** button is displayed, you may use it to go back and make changes to a previous entry.

Modifying User Accounts

1. Log on as **Administrator**.
2. If you are not already working from the physical library, select it from the **View** menu. Refer to [Selecting a Library or Partition](#).

3. Select **Setup—> Users**.

The **Users** dialog box appears.

4. Select the name of the account you wish to modify.
5. Select **Modify**.

The **User Account Type** dialog box is displayed.

6. If you are changing the password, enter the new password into the **Enter Password** text box.

If you are not changing the password, leave the **Enter Password** text box blank.



NOTE: Best practice is to change all account passwords periodically.

7. If you changed password, re-enter the new password into the **Confirm Password** text box.

If you are not changing the password, leave the **Confirm Password** text box blank.

If the privilege level is **User**, proceed to [Step 8](#).

If you are not changing the privilege level, and the privilege level is **Administrator**, select **Finish** to register the password change. To close the dialog box, select **Cancel**.

- If the privilege level is set to **User**, the **Assign Partitions** dialog box opens.

For a list of commands available to the administrator and those available to the user, refer to [Table 4](#).

- Select **Select All** to assign access to all listed libraries, or select certain lines to assign access only to certain libraries.
- Select **Finish** to register library access decisions.

Deleting User Accounts

- Log on as **Administrator**.
- If you are not already working from the physical library, select it from the **View** menu. Refer to [Selecting a Library or Partition](#).
- Select **Setup—> Users**.

The **Users** dialog box appears.

- Select the name of the account you wish to delete.
- Select **Delete**.
- You are asked to confirm that the account should be deleted.

If you do not confirm, you are returned to the **Users** dialog box.

If you do confirm, the account is deleted, and you are returned to the **Users** dialog box.

- Delete another account, or select **Close**.

Understanding Location Coordinates

The library uses a coordinate system that defines each element location by means of the following component designations: aisle, module, rack, section, column, and row.

Cartridge Locations

The Library Management Console uses dialog boxes like the one in [Figure 1](#) to allow you to specify locations. These coordinates can be reported in parenthetical format, each element separated by commas. In parenthetical format, the location for the device listed in the **Load Drives** dialog box below would be written (1,1,2,2,2,2). This means that the device is to be found on the door side of the control module, in the second of the six rows in the second magazine from the top of column 2. In [Figure 4](#) this space is labeled.

Figure 1. Location Coordinates Used in the Load Drives Dialog Box

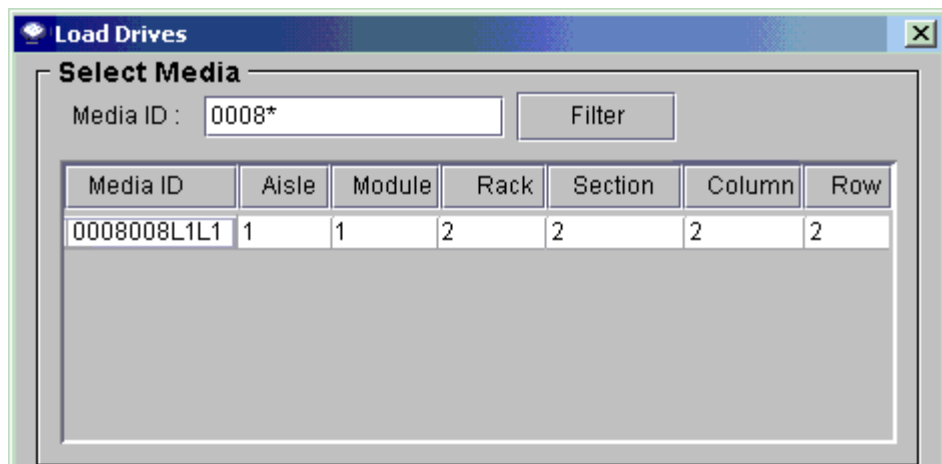

Here is the key to interpreting location coordinates.

Aisle

The designation for the aisle is always "1" for the library, because there is only one aisle.

Module

The designation for the module is based on the sequential numbering of the modular components. For a library consisting of a single control module, the module or "frame" is "1." As you add expansion modules, the numbering increments by one for each expansion module. A library that contains one control module and all three expansion modules has four total module locations. Refer to [Table 1](#).

Table 1. Module Numbering

1	1- 4				
Aisle	Module	Rack	Section	Column	Row

Rack

The designation for the rack is based on the distinction of door-side versus drive-side. The rack on the drive-side of the library is "1." The rack on the door-side is "2." Refer to [Table 2](#) and [Figure 2](#).

Table 2. Rack Numbering

1	1- 4	1 - 2			
Aisle	Module	Rack	Section	Column	Row

Figure 2. Rack Numbering

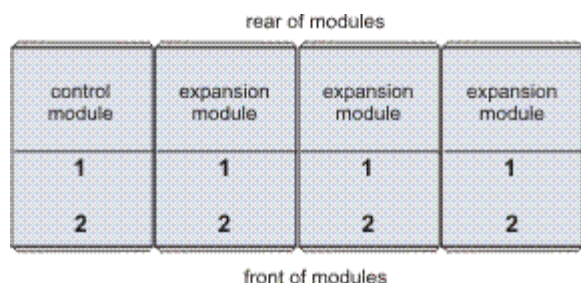

Column, Section, Row

There are four columns per rack when there are no I/E stations or drives in the module. When there are drives or I/E stations, there are only two full columns and a partial column of storage per rack. Compare [Figure 3](#), [Figure 4](#), and [Figure 6](#). On a drive-side rack, section "6" is reserved for the middle x-axis rail, and this section is designated as column "1" across the entire width of the rack.

- Columns are numbered from left to right as you face the rack.
- There are ten storage sections per door-side column and nine storage sections per drive-side column.
- Storage sections are numbered from the top down.
- The number of rows per section varies per media type. One storage section is equal to one magazine. An LTO storage magazine, for example, consists of slots for six cartridges. Hence, there are six rows per section in a library configured for LTO.

Table 3. Storage cell location coordinates

1	1-4	1-2	1-10	1-4	1-6

Aisle	Module	Rack	Section	Column	Row
-------	--------	------	---------	--------	-----

Figure 3. Door-side Location Coordinates for a Unit Without an I/E Station

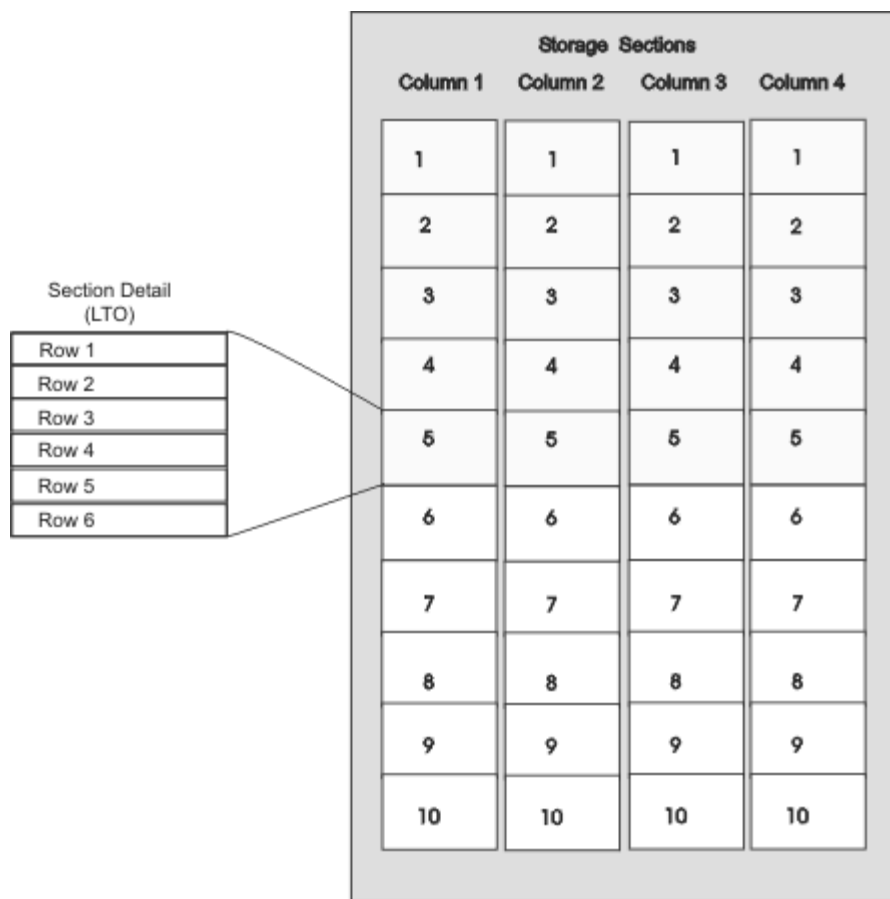
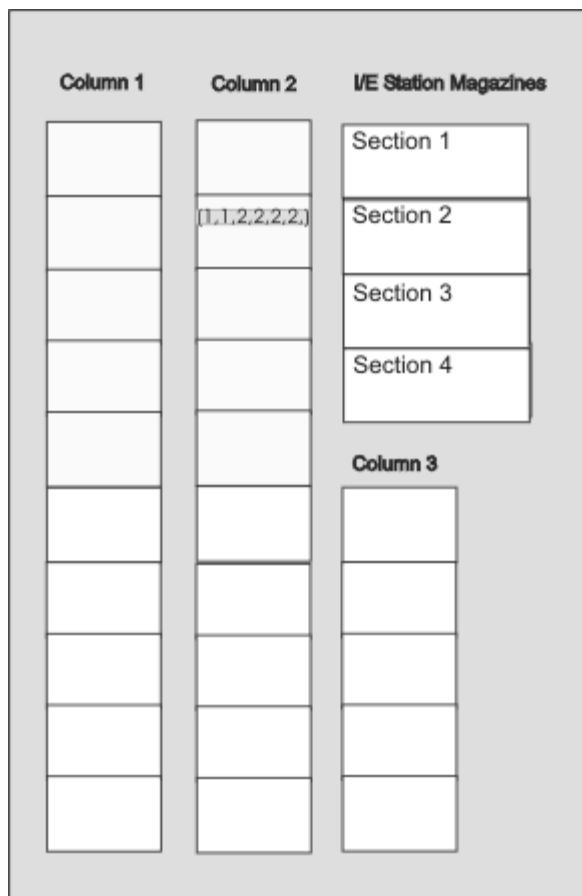

Figure 4. Door-side Location Coordinates for a Unit With an I/E Station



Tape Drive Location Coordinates

The designation for drives is based on the position of the drive in the module and section.

- Tape drives are always in rack "1", column "1" of a particular module.
- Columns are read from left to right as you face the rack.
- The number of drive sections in a rack varies per media type. Full height drives, like LTO, have twelve sections. All drives are in row "1" of the relevant section.
- The library can accommodate two six-drive LTO drive clusters per rack. The number of drives in a drive cluster varies by drive type.
- Drive number "1" is in the lowest section of the lower drive cluster. Drives are numbered from bottom to top. [Figure 6](#) calls out the physical location of drive 9, which is the last of the drives cited in the **Move Media** dialog box shown in [Figure 5](#). Compare with [Table 4](#).

Figure 5. Location Coordinates for Drives

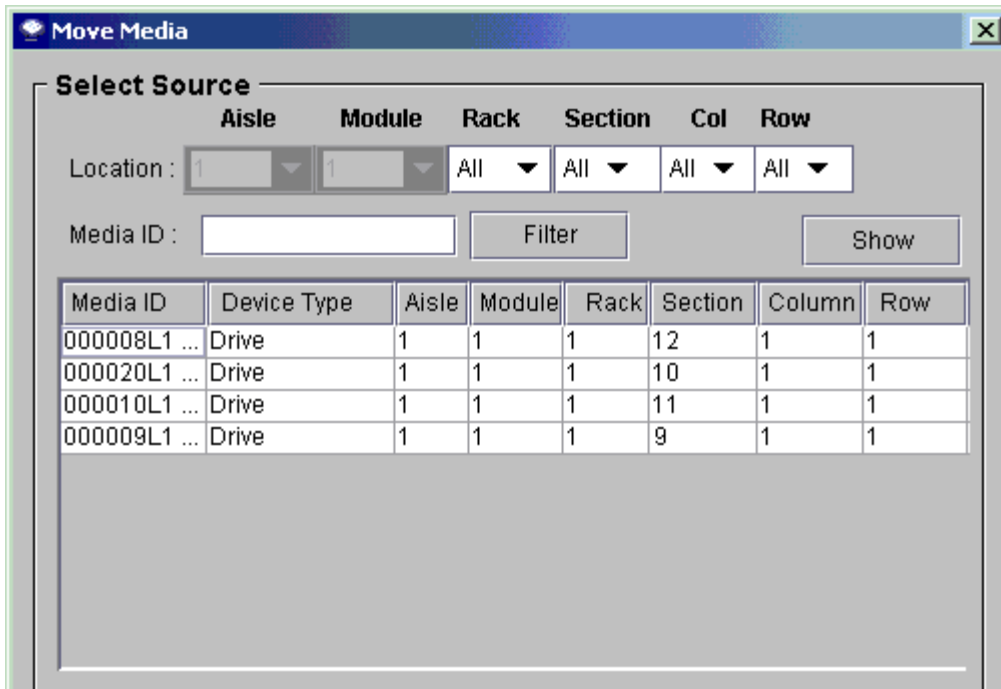
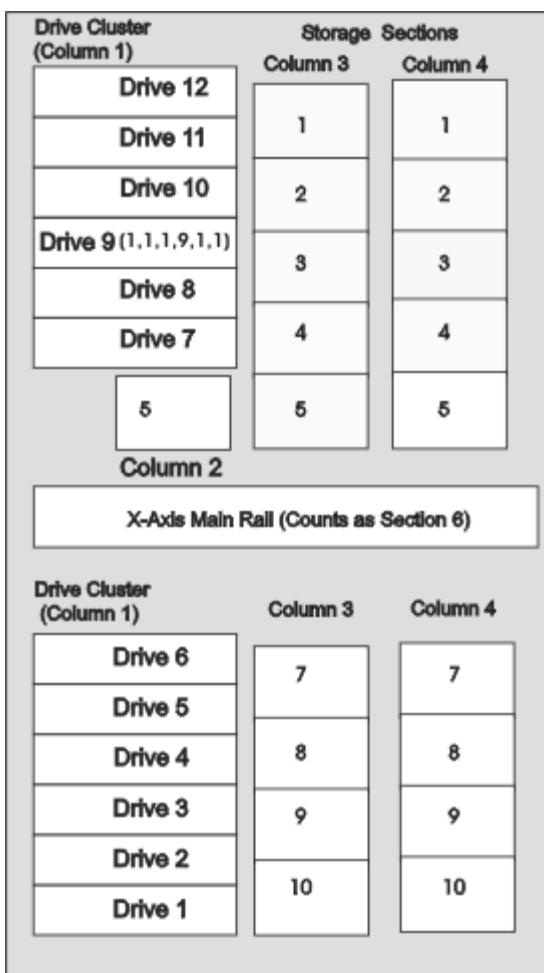

Table 4. Drive Numbering

1	1-4	1	1-12	1	1
Aisle	Module	Rack	Section	Column	Row

Figure 6. Drive-side Location Coordinates



[Back to Contents Page](#)

[Back to Contents Page](#)

Frequently Asked Questions: Dell™ PowerVault™ 160T Tape Library User's Guide

- [Where do I find cabling instructions?](#)
- [After installation, what do I do?](#)
- [Where are error messages defined?](#)
- [How do I upgrade software?](#)
- [How do I clean a drive?](#)
- [How do I know when the drives need cleaning?](#)
- [What is a partition?](#)
- [Where can I find the serial number?](#)
- [How many characters can be on the barcode?](#)
- [What barcode formats are supported?](#)
- [What do I do if I lose my password?](#)
- [What do I do if I lose power during a backup?](#)

Here are answers to some of the questions most commonly asked about operating the library.

Where do I find cabling instructions?

[Cabling](#) instructions are covered in the [Getting Started](#) section of this guide.

After installation, what do I do?

Follow the instructions in [Logging on Locally](#) and [Running the Setup Wizard](#).

Where are error messages defined?

The **Service Wizard** walks you through any reported errors and even tells you when you should be [Getting Help](#) from Dell Support.

How do I upgrade software?

Refer to [Updating the Software](#).

Your service representative will show you where to find a file containing updates to software or firmware for the drives, robotics control unit (RCU), library management module (LMM), management control blade (MCB), and Library Management Console. Once you point the **Update Software** tool at the correct file, the MCB will update all appropriate components.

How do I clean a drive?

Use your backup software to clean the drives. For detailed instructions, refer to [Using Cleaning Cartridges](#).

How do I know when the drives need cleaning?

The host application will tell you. Refer to [Using Cleaning Cartridges](#).

What is a partition?

A partition is an abstraction of an underlying physical library that will be considered a different personality, capacity, or both to a host. It is a collection of real physical elements, combined to create a grouping that is different from the physical library, and is often dedicated to a single host application. Another term for partition is "logical library." For a more detailed discussion, read [Working with Partitions](#). To learn how to create a partition, go to [Creating Partitions](#).

Where can I find the serial number?

The serial number is displayed in the second column of the first line output by **Monitor—> System**. Use the serial number when [Getting Help](#) from Dell Support.

How many characters can be in the barcodes?

The library reads barcodes up to 16 characters. For more about barcodes, refer to [Barcode Requirements](#).

What barcode formats are supported?

Cartridges must have an external barcode label that is machine-readable to identify the volume serial number. A barcode must use only uppercase letters A to Z and/or numeric values 0 to 9. The library currently supports Code 39 type barcode labels. For more about barcodes, refer to [Barcode Requirements](#).

What do I do if I lose my password?

Contact Dell Support for instructions to reset the password. Refer to [Getting Help](#).

What do I do if I lose power during a backup?

Because your system contains redundant power supplies, it is unlikely that power will ever be completely unavailable to the library. However, the library should recover even if power does go out completely during a backup. If power remains off, press the **Power** button and leave it in the off position until a reliable power source is obtained. Once the power to the library is turned back on, the library will recover. You will need to re-run the backup using your application software.

[Back to Contents Page](#)

[Back to Contents Page](#)

Maintaining Your Library: Dell™ PowerVault™ 160T Tape Library User's Guide

- [Monitoring Library Subsystems](#)
- [Maintenance Actions for all Users](#)
- [Maintenance Actions for Administrative Users](#)

The Dell PowerVault 160T provides advanced system monitoring and alerting mechanisms without the use of an external troubleshooting framework. Events provide data that provides operational feedback and guides service technicians through diagnoses and corrective actions that can be taken before a problem can interfere with a backup.

The **Monitor** menu displays detailed information about the system, the drives, connectivity, the I/E stations, slots, and media. The **Tools** menu allows administrators to test the drives, to capture a snapshot, to update software, and to calibrate and configure the robot. The **Service Wizard** on the **Tools** menu is a troubleshooting tool available to administrative users. For information about its use, refer to [Troubleshooting](#).

Monitoring Library Subsystems

The library allows you to get detailed status information grouped by one of six different menus:

- System
- Drive
- Connectivity
- I/E station
- Slots
- Media

You can also use the system status buttons to obtain this information. Refer to [System Status Buttons](#).

Monitoring System Status

Use the **Monitor—> System** command to display status information for various components.

1. If you have created a partition, use the **View** menu to select the appropriate library or partition. To find out how to do so, refer to [Selecting a Library or Partition](#).
2. Select **Monitor—> System**.

The **System Status** dialog box is displayed.

For each component you can view: the component's name, its ID, and its status. [Table 1](#) explains the items listed in the dialog box.

Table 1. Monitor—> System Dialog Box Output

Description	ID	Description
Library	[Serial number]	Online/Offline
Media Moves	[Robot number, if available]	[Number of media moves within the history of the library]
Recovered Gets	[Robot number, if available]	[Number of recovered gets within the history of the library]
Recovered Puts	[Robot number, if available]	[Number of recovered puts within the history of the library]

	available]	
Recovered Scans	[Robot number, if available]	[Number of recovered scans within the history of the library]
MCB Status	[Serial number]	Good, Degraded, Failed
RCU Status	[Serial number]	Good, Degraded, Failed
Vertical Motion	N/A	[Number of meters traveled within the history of the library]
Horizontal Motion	N/A	[Number of meters traveled within the history of the library]

Recording the information in the display

1. Select **Send** at the bottom of the **System Status** dialog box.

The **Email, Save, or Print Table** dialog box is displayed.

2. Do one of the following:

- o Enter the e-mail address for a recipient into the text box after **e-mail**, then select **OK**.

 **NOTE:** If you have not previously configured e-mail settings, go to [Configuring E-mail Settings](#). Then return to this section.

- o Enter a filename into the text box after the **Save** option. Use the file browser to save to the location you want.
- o Select **Print**.

 **NOTE:** You can e-mail, save, and print from a remote client. You can only e-mail from the local client.

3. Select **OK** to send.

Monitoring Drive Status

Use the **Monitor—> Drives** command to display detailed information about the tape drives in the currently selected partition. If you are working in the physical library, status information for all drives is displayed.

1. If you have created a partition, use the **View** menu to select the appropriate library or partition. To find out how to do so, refer to [Selecting a Library or Partition](#).
2. Select **Monitor—> Drives**.

The **Drive Status** dialog box is displayed.

For each drive you can view: the drive type, WWN, firmware level, loaded or not loaded, location, serial number, and vendor. [Table 2](#) defines the parameters used in the dialog box.

Table 2. Monitor—> Drives Dialog Box Output

Description	Definition
Type	Drive type
WWN	For a Fibre drive, the WWN
Firmware level	Drive firmware
Loaded	Current state of drive: loaded, loading, unloaded, or empty
Location	Refer to Understanding Location Coordinates
Serial number	Drive serial number
Vendor	Drive vendor

Recording the information in the display

1. Select **Send** at the bottom of the **Drive Status** dialog box.

The **Email, Save, or Print Table** dialog box is displayed.

2. Do one of the following:

- o Enter the e-mail address for a recipient into the text box after **Email**, then select **OK**.

 **NOTE:** If you have not previously configured e-mail settings, go to [Configuring E-mail Settings](#). Then return to this section.

- o Enter a filename into the text box after the **Save** option. Use the file browser to save to a location different from the default. The default location is \SNC Manager\app\Client.
- o Select **Print**.

 **NOTE:** You can e-mail, save, and print from a remote client. You can only e-mail from the local client.

3. Select **OK** to send.

Monitoring Connectivity

Use the **Monitor—> Connectivity** command to display status information about the I/O blades or the FC and SCSI connections on the MCB.

1. If you have created a partition, use the **View** menu to select the appropriate library or partition. To find out how to do so, refer to [Selecting a Library or Partition](#).
2. Under **Monitor—> Connectivity** there are three choices: **IO Blade**, **SCSI Channel**, and **Fibre Channel**. The **IO Blade** is not available.
 - If you choose SCSI Channel, the **SCSI Channel Status** dialog box is displayed.

For an explanation of the data elements that are included, refer to [Table 4](#).

Table 4. Monitor—> Connectivity—> SCSI Channel Dialog Box Output

Description	Definition
Port Index	Port number
Location	Blade
Port Mode	Target or Initiator
Status	Operational, Lost Sync
Host ID	SCSI ID
Termination	Terminated or Not Terminated
Alternate ID	Alternate SCSI ID
Bus Reset	Bus configured to reset on power up or not

- If you choose Fibre Channel, the **Fibre Channel Status** dialog box is displayed.

For an explanation of the data elements that are included, refer to [Table 5](#).

Table 5. Monitor—> Connectivity—> Fibre Channel Dialog Box Output

Description	Definition
Port Index	Port number
Location	Blade

Port Mode	Target or Initiator
Status	Operational, Lost Sync
WWPN	World Wide Port Name
Loop ID	If connection is arbitrated loop, the loop ID
Connection	Loop, Point to Point, Loop Preferred, Point to Point Preferred
Speed	1 Gb/s, 2 Gb/s, or Auto

Monitoring I/E Station Status

Use the **Monitor—> I/E Station** command to display detailed information about the I/E stations in the currently selected partition. If you are working in the physical library, status information for all I/E stations is displayed.

1. If you have created a partition, use the **View** menu to select the appropriate library or partition. To find out how to do so, refer to [Selecting a Library or Partition](#).
2. Select **Monitor—> I/E Station** or use the **I/E** toolbar button.

The **I/E Station Status** dialog box is displayed.

You can view the following for each I/E station: the I/E station number, magazine number, media ID, and slot type. [Table 6](#) explains the information that the dialog box displays.



Table 6. Monitor—> I/E Station Dialog Box Output

Table Label	Definition
I/E Station number	The I/E station number is the same as the control module or expansion module that contains it.
Magazine number	I/E station magazines are numbered from top to bottom.
Media ID	The I/E station barcode.
Slot Type	Media type, for example, LTO.

Recording the Information in the Display

1. Select **Send** at the bottom of the **I/E Station Status** dialog box.

The **Email, Save, or Print Table** dialog box is displayed.

2. Do one of the following:
 - o Enter the e-mail address for a recipient into the text box after **Email**, then select **OK**.
 -  **NOTE:** If you have not previously configured e-mail settings, go to [Configuring E-mail Settings](#). Then return to this section.
 - o Enter a filename into the text box after the **Save** option. Use the file browser to save to a location different from the default. The default location is \SNC Manager\app\Client.
 - o Select **Print**.
 -  **NOTE:** You can e-mail, save, and print from a remote client. You can only e-mail from the local client.
3. Select **OK** to send.

Monitoring Slot Status

Use the **Monitor—>Slots** command to display detailed information about the slots in the currently selected partition. If you are working in the physical library, you can view status information for all slots. Because the number of slots in a physical or partition can be quite large, you can select a subset of the available slots.

1. If you have created a partition, use the **View** menu to select the appropriate library or partition. To find out how to do so, refer to [Selecting a Library or Partition](#).
2. Select **Monitor—> Slots**.

The **Slots Status** dialog box is displayed.

For each slot, you will see a media ID, location, the slot type and the number of times the robot has put a cartridge in the slot. [Table 7](#) explains the information that the dialog box displays.

Table 7. Monitor—> Slots Dialog Box Output

Description	Definition
Media ID	The slot barcode
Location	Refer to Understanding Location Coordinates
Slot Type	Media type, for example, LTO
# Puts	[Number of puts within the history of the library]

Selecting a Subset of Slots

The top of the **Slots Status** dialog box contains scroll boxes you can use to remove slots from the status list. This area is labeled **Filter**.

1. To specify a particular location, select the arrows beside the boxes associated with the different components of the location coordinates. The default selection is **All**.
 - o For example, changing the **Module** to **1** and the **Rack** to **1** in the **Location** row limits the selection to the drive side rack of the control module. For more information, refer to [Understanding Location Coordinates](#).
 - o Changing the **Slot Type** to a specific media type limits the selection to the specified media type.
 - o Changing the **State** to **Occupied** or **Empty** limits the selection to slots in the specified state.
2. Select **Show**.

Recording the Information in the Display

1. Select the **Send** button in the **Filter** area of the **Slots Status** dialog box.

The **Email, Save, or Print Table** dialog box is displayed.

2. Do one of the following:
 - o Enter the e-mail address for a recipient into the text box after **Email**, then select **OK**.



NOTE: If you have not previously configured e-mail settings, go to [Configuring E-mail Settings](#). Then return to this section.

- o Enter a filename into the text box after the **Save** option. Use the file browser to save to the location you want.
- o Select **Print**.



NOTE: You can e-mail, save, and print from a remote client. You can only e-mail from the local client.

3. Select **OK** to send.

Monitoring Media Status

Use the **Monitor—> Media** command to display detailed information about the media in the currently selected partition. If

you are working in the physical library, you can view status information for all media. Because the number of media in a physical or partition can be quite large, you can select a subset of the available slots.

1. If you have created a partition, use the **View** menu to select the appropriate library or partition. To find out how to do so, refer to [Selecting a Library or Partition](#).
2. Select **Monitor—> Media**.

The **Media Status** dialog box is displayed.

For each cartridge, you can view: media ID, media type, the location, and the number of mounts. [Table 8](#) explains the information that the dialog box displays.

Table 8. Monitor—> Media Dialog Box Output

Description	Definition
Media ID	The cartridge barcode
Media Type	A format/size of media, for example, LTO
Location	Refer to Understanding Location Coordinates
# Mounts	[Number of mounts within the history of the library]

Selecting a Subset of Media

The top of the **Media Status** dialog box consists of scroll boxes that can be set to filter out media for which you do not want to check status. This area is labeled **Filter**.

1. Do one of the following things:
 - o Type the barcode associated with a particular cartridge into the **Media ID** text box. Or use the media filter to perform a search for media IDs that match or contain a particular pattern. For, the media ID filter could be set to "J00*" (without the quotation marks) to produce a list of cartridges containing the string "J00" in their barcodes.
 - o To limit the selection to the specified media type, select the arrow beside the **Media Type** scroll box. Select a number to replace the default value.
2. Select **Show**.

Recording the Information in the Display

1. Select the **Send** button in the **Filter** area of the **Slots Status** dialog box.

The **Email, Save, or Print Table** dialog box is displayed.

2. Do one of the following things:
 - o Enter the e-mail address for a recipient into the text box after **Email**, then select **OK**.
-  **NOTE:** If you have not previously configured e-mail settings, go to [Configuring E-mail Settings](#). Then return to this section.
- o Enter a filename into the text box after the **Save** option. Use the file browser to save to the location you want.
 - o Select **Print**.

 **NOTE:** You can e-mail, save, and print from a remote client. You can only e-mail from the local client.

3. Select **OK** to send.

Maintenance Actions for All Users

If you are experiencing system problems, make a quick check of subsystems and components before looking for a service ticket or [Getting Help](#) from Dell Support. Your service representative may ask you to check these things or—if you are the administrator—you may be asked to run a diagnostic procedure, or upload new software. For details about diagnostic procedures and software uploads, refer to [Maintenance Actions for Administrative Users](#).

Is the Front Door Closed?

Library operations are taken offline when the front door is opened. If library operations have stopped, first make sure that the front door is shut and the **Robotics Enabled** indicator is solid green.

Is a Cartridge Lodged in the Library?

It is very unlikely that a cartridge will be lodged in the robot. If this happens, open the door and pull the cartridge out.

It is also very unlikely that a cartridge will become lodged in a drive. If this happens, it is not difficult to remove it.

Removing a Cartridge Lodged in a Drive

1. Open the door.
2. Press the blue button on the drive.
3. If the cartridge was not ejected, follow the instructions from the drive manufacturer.

Is a Cartridge Old?

Cartridges can become old and less dependable. If you are having problems reading, writing, or otherwise using a cartridge, refer to the following list of potential courses of action.

- Use **Monitor**—> **Media** to check the number of mounts for the cartridge, and compare it to other cartridges in the system. If it has been used excessively, replace it with a new cartridge.
- Try using the cartridge in a different drive. Use **Tools**—> **Drives** to check the error count. If it continues to increase, replace the old cartridge with a new cartridge.
- If you have received a message about read/write failures, first copy the data from the failing cartridge then replace it with a new cartridge.

Do you Need to Cycle Power?

If library firmware seems to be at fault, the robot will not move, or a circuit board has gone down, try recycling power to the library.

1. Log in as **Administrator**.
2. Select **Operations**—> **Change Mode**.



NOTICE: Do not power cycle the library for a drive problem. Use **Tools**—> **Drives** to power cycle the drive.

3. Select **Shutdown**.
4. Once the touch screen display is dark, press the **Power** button.
5. Press the **Power** button again to restart.

Maintaining the Air Filter

Each control and expansion module contains two air filters, one at the top and one at the bottom of the front door. The total number of tape drives and the operating environment significantly affect the rate at which debris accumulates in the filter.

When the maximum number of tape drives are contained in a library that is operating in a normal data center environment, you should check the filters every two years. If dust and debris are visible on the inlet side of the filter, use

water and a mild soap to clean the air filters. The materials in the filter should last the life of the product. However, if abnormal contamination occurs, replacement filters are available. Please contact your service representative to order.

Maintenance Actions for Administrative Users

Administrative users have access to the commands on the **Tools** menu. Use this menu to test the drives, as well as to capture a snapshot, to update software, and to use the **Teach** tool. The **Service Wizard** on the **Tools** menu is a troubleshooting aid. For information about its use, refer to [Troubleshooting](#).

Configuring and Testing Drives

The **Drives** command on the **Tools** menu allows you to reset drives.

1. Log in as **Administrator**.
2. Use the **View** menu to select the physical library. To find out how to do so, refer to [Selecting a Library or Partition](#).
3. Select **Tools—> Drives**.

The **Drives** dialog box is displayed. In it each drive is characterized by its state, its media type, and its location. If the current library is a physical library, you will be able to filter for media type.

4. Select the drive that you want to reset, reconfigure, or identify.
5. Perform one of the operations described in the following table.

Table 9. Tools—> Drives Dialog Box Settings

Command Group	Command	Description
Settings	Configures Speed	Configures speed of LTO-2 FC drives. The choices are 1 Gb/sec, 2 Gb/sec, and Auto.
	Configure Port Mode	Configures port mode of LTO-2 drives. The choices are N_Port (not loop capable), NL_Port (loop capable) and Auto.
Control	Power Cycle¹	Causes power to be removed from and then restored to the drive.
	Reset Drive¹	Causes the drive to refresh without cycling the power.
	Vary Off	Causes the dialog box to display the current state of the drive and toggle it to the other state every time you select the Vary Off button. Use this setting when you hot swap drives.
	Identify	Causes the LEDs on the drive to flash, so that you can identify it.
Self Test		The test suite is not currently available.
¹ Generally, try to reset the drive before cycling power to the drive.		

6. To close the dialog box, select **Cancel**.

Getting Details about Drive Test Errors

The tests you run from the **Tools** menu look for error conditions in the library system. System status buttons report information when an error condition occurs.

To see details about reported errors select **Tools—> Service**. For more information, refer to [Troubleshooting](#).

Capturing a Snapshot

The **Capture Snapshot** command allows you to obtain and preserve detailed information about the state of the entire system. By default, information is collected about all system components.

1. Log on as **Administrator**.
2. Use the **View** menu to select the physical library. To find out how to do so, refer to [Selecting a Library or Partition](#).
3. Take the physical library offline. For instructions, refer to [Selecting a Mode](#).
4. Select **Tools—> Capture Snapshot**.

The **Capture Snapshot** dialog box is displayed.

5. Select the components for which you want detailed status information. The choices are:
 - o All (this is the default choice)
 - o MCB
 - o RCU
 - o All I/O blades
6. To close the dialog box without getting the report, select **Cancel**.

Recording the Information in the Snapshot

1. Select **Send** at the bottom of the **Capture Snapshot** dialog box.

The **Email, Save, or Print Table** dialog box is displayed.

2. Do one of the following things:
 - o Enter the e-mail address for a recipient into the text box after **Email**, then select **OK**. The e-mail address for technical support at Dell is **support@dell.us.com**.

 **NOTE:** If you have not previously configured e-mail settings, go to [Configuring E-mail Settings](#). Then return to this section.

 - o Enter a filename into the text box after the **Save** option. Use the file browser to save the file to the location you want.

 **NOTE:** You can e-mail and save from a remote client. You can only e-mail from the local client.
3. Select **OK** to send, or **Cancel** to quit the **Email, Save, or Print Table** dialog box.
4. Select **Close** to exit the details dialog box and **Close** again to exit the status dialog box for the degraded or failed component.

Updating the Software

 **NOTE:** You can upload software only from a remote console.

You can update firmware, software, or microcode for library components by using the **Update Software** command. Your service representative will provide you with the update file. You can load the file onto a remote system in your LAN, or the service representative can connect to the library by using the Ethernet connector on the MCB. The update file is composed of code updates for one or all of the following components:

- Drive sled firmware
- RCU firmware
- MCB firmware
- I/O blade firmware
- SNC Manager software

After you point the file browser at the file update package, the program deposits the package in a predetermined location in

the management control blade (MCB) file structure. The MCB then distributes the various components of the update package to the proper library subcomponents.

1. Log on as **Administrator**.
2. Use the **View** menu to select the physical library. To find out how to do so, refer to [Selecting a Library or Partition](#).
3. Select **Tools—> Update Software**.

You are prompted to take the library offline.

4. If you are ready to proceed, select **Yes**. If you are not ready to proceed, select **No**.

If you select **Yes**, the **Update Software** file browser is displayed.

The browser window defaults to a search for files with the extension .rpm.

5. Point the file browser at the location where the .rpm file is located.
6. Select **Select** to load the software. An .rpm file installer will open and component files in the .rpm package will be directed to the correct library subcomponents.

When the update is finished, the system restarts automatically.

After the system has restarted, it begins discovering SAN components, drives, and blades.

7. When the discovery is completed, put the physical library back online. For instructions, refer to [Selecting a Mode](#).
8. Select **Help—> About**.
9. Verify that the update version in the **About Dell PowerVault 160T** window matches the version of software that you just loaded.

If the displayed update version is not correct, contact your service representative.

Running the Teach Test

The **Teach** test configures or calibrates the library.

When the library is first powered on the gripper moves to the home position, which it identifies as being at X-Y coordinate position 0,0. It then moves to a magazine at the top and a magazine at the bottom on each side of each frame, and stores those positions in coordinates relative to the 0,0 position. Calibration is not performed again automatically.

The **Calibrate** option of the **Teach Test** routine provides your library with fresh calibration information. After calibration, the gripper moves to each storage magazine, I/E magazine, and drive in the library and stores information about them as part of configuration. Configuration is not performed again automatically. The **Configure** option of the **Teach Test** routine provides your library with fresh configuration information.

After calibration and configuration, the gripper scans all media in all the storage and I/E locations to build an inventory. Use the **Physical Library** command on the **Setup** menu to disable or enable automatic inventory on startup. For more information on this command, refer to [Setting up Policies for the Physical Library](#).

Reconfiguring the Library

1. Take the physical library offline. For instructions, refer to [Selecting a Mode](#).
2. Select **Tools—> Teach**.

The **Teach Test** dialog box is displayed. The default choice is **Configure**.

3. Select **Start**.

Test results are displayed in the **Results** text box when the test is finished.

4. Select **Cancel** to close the dialog box.
5. For information about reported errors, proceed to [Troubleshooting](#).

Calibrating the Library

1. Take the physical library offline. For instructions, refer to [Selecting a Mode](#).

2. Select **Tools—> Teach**.

The **Teach Test** dialog box displays. The default choice is **Configure**.

3. Select **Calibrate**.

4. Select **Start**.

Test results are displayed in the **Results** text box when the test is finished.

5. Select **Cancel** to close the dialog box.

6. For information about reported errors, proceed to [Troubleshooting](#).

[Back to Contents Page](#)

[Back to Contents Page](#)

Troubleshooting: Dell™ PowerVault™ 160T Tape Library User's Guide

- [Displaying Service Tickets](#)
- [Getting Problem Details](#)

The **Service** wizard shows you service tickets and walks you through the actions that you need to take to restore library functionality. You must initiate the **Service** wizard manually. In most cases, the **Service** wizard will point you to the specific FRU that needs servicing and/or replacing.

Displaying Service Tickets

When errors occur in the library, the system status buttons display the component as either degraded or failed. You can view the ticket associated with a specific group by pressing the button, or you can pull up a listing of all the tickets using the following procedure.

 **NOTE:** Only service representatives and administrators can see service tickets. When a service ticket is active, users and guests cannot use the Library Management Console.

Use the following procedure to see the entire problem history list.

1. Select **Tools**—> **Service** or use the **Service** button on the toolbar.

The **Service Wizard** dialog box is displayed.

2. Choose either **Fix Current Problems** or **See Problem History List**.

Retrieving problem tickets can take some time.

If service representatives ask you to send problem details, select the problem and then refer to the instructions in [E-mailing, Printing, or Saving the Information in the Detail](#).

Getting Problem Details

If you want to see problem details, select a problem and then select **See Details**. The **Problem Details** dialog box is displayed. This ticket will be closed automatically when the problem is resolved. If you want to close it manually, do so by selecting **Close Ticket**.

The system can issue a report for you about a problem that has occurred more than once. To see a report about this problem, select **Reports**. Available reports are listed in the **Reports** dialog box.

Information in the report includes the reason for the problem, the recommended action, and when the problem occurred. Each reports relates to a single system group. If a ticket is closed and the identical problem occurs in the system within 30 minutes, the ticket is reopened.

To add a comment report to a ticket that you have viewed, cancel the report details and then select **Add Comments** on the **Create New Report** dialog box.

E-mailing, Printing, or Saving the Information in the Detail

1. Select **Send** at the bottom of the status dialog box.

The **Email, Save, or Print Table** dialog box is displayed.

2. Do one of the following things:

- Enter the e-mail address for a recipient into the text box after **Email**, then select **OK**.

 **NOTE:** If you have not previously configured e-mail settings, go to [Configuring E-mail Settings](#). Then return to this section.

- Enter a filename into the text box after the **Save** option. Use the file browser to save to a different location than the default. The default location is \SNC Manager\app\Client.
- Select **Print** to bring up your operating system's print routine.

 **NOTE:** You can e-mail, save, and print from a remote client. You can only e-mail from the local client.

3. Select **OK** to send.

Select **Close** to exit the details dialog box and **Close** again to exit the status dialog box for the degraded or failed component.

[Back to Contents Page](#)

[Back to Contents Page](#)

Getting Help: Dell™ PowerVault™ 160T Tape Library User's Guide

- [Technical Assistance](#)
 - [Dell Enterprise Training and Certification](#)
 - [Problems With Your Order](#)
 - [Product Information](#)
 - [Returning Items for Warranty Repair or Credit](#)
 - [Before You Call](#)
-

Technical Assistance

If you need assistance with a technical problem, perform the following steps:

1. Complete the procedures in "Troubleshooting Your System."
2. Run the system diagnostics and record any information provided.
3. Use Dell's extensive suite of online services available at Dell Support at **support.dell.com** for help with installation and troubleshooting procedures.

For more information, see "[Online Services](#)."

4. If the preceding steps have not resolved the problem, call Dell for technical assistance.

 **NOTE:** Call technical support from a phone near or at the system so that technical support can assist you with any necessary procedures.

 **NOTE:** Dell's Express Service Code system may not be available in all countries.

When prompted by Dell's automated telephone system, enter your Express Service Code to route the call directly to the proper support personnel. If you do not have an Express Service Code, open the **Dell Accessories** folder, double-click the **Express Service Code** icon, and follow the directions.

For instructions on using the technical support service, see "[Technical Support Service](#)" and "[Before You Call](#)."

 **NOTE:** Some of the following services are not always available in all locations outside the continental U.S. Call your local Dell representative for information on availability.

Online Services

You can access Dell Support at **support.dell.com**. Select your region on the **WELCOME TO DELL SUPPORT** page, and fill in the requested details to access help tools and information.

You can contact Dell electronically using the following addresses:

- World Wide Web

www.dell.com/

www.dell.com/ap/ (for Asian/Pacific countries only)

www.euro.dell.com (for Europe only)

www.dell.com/la (for Latin American countries)

- Anonymous file transfer protocol (FTP)

ftp.dell.com/

Log in as `user:anonymous`, and use your e-mail address as your password.

- Electronic Support Service

support@us.dell.com

apsupport@dell.com (for Asian/Pacific countries only)

support.euro.dell.com (for Europe only)

- Electronic Quote Service

sales@dell.com

apmarketing@dell.com (for Asian/Pacific countries only)

- Electronic Information Service

info@dell.com

AutoTech Service

Dell's automated technical support service—AutoTech—provides recorded answers to the questions most frequently asked by Dell customers about their portable and desktop computer systems.

When you call AutoTech, use your touch-tone telephone to select the subjects that correspond to your questions.

The AutoTech service is available 24 hours a day, 7 days a week. You can also access this service through the technical support service. See the contact information for your region.

Automated Order-Status System

You can call the automated service to check on the status of any Dell products that you have ordered. A recording prompts you for the information needed to locate and report on your order. See the contact information for your region.

Technical Support Service

Dell's technical support service is available 24 hours a day, 7 days a week, to answer your questions about Dell hardware. Our technical support staff use computer-based diagnostics to provide fast, accurate answers.

To contact Dell's technical support service, see "[Before You Call](#)" and then see the contact information for your region.

Dell Enterprise Training and Certification

Dell Enterprise Training and Certification is available now; see www.dell.com/training for more information. This service may not be offered in all locations.

Problems With Your Order

If you have a problem with your order, such as missing parts, wrong parts, or incorrect billing, contact Dell for customer

assistance. Have your invoice or packing slip available when you call. See the contact information for your region.

Product Information

If you need information about additional products available from Dell, or if you would like to place an order, visit the Dell website at www.dell.com. For the telephone number to call to speak to a sales specialist, see the contact information for your region.

Returning Items for Warranty Repair or Credit

Prepare all items being returned, whether for repair or credit, as follows:

1. Call Dell to obtain a Return Material Authorization Number, and write it clearly and prominently on the outside of the box.

For the telephone number to call, see the contact information for your region.
2. Include a copy of the invoice and a letter describing the reason for the return.
3. Include a copy of any diagnostic information indicating the tests you have run and any error messages reported by the system diagnostics.
4. Include any accessories that belong with the item(s) being returned (such as power cables, media such as CDs and diskettes, and guides) if the return is for credit.
5. Pack the equipment to be returned in the original (or equivalent) packing materials.

You are responsible for paying shipping expenses. You are also responsible for insuring any product returned, and you assume the risk of loss during shipment to Dell. Collect-on-delivery (C.O.D.) packages are not accepted.

Returns that are missing any of the preceding requirements will be refused at our receiving dock and returned to you.

Before You Call



NOTE: Have your Express Service Code ready when you call. The code helps Dell's automated-support telephone system direct your call more efficiently.

If possible, turn on your system before you call Dell for technical assistance and call from a telephone at or near the computer. You may be asked to type some commands at the keyboard, relay detailed information during operations, or try other troubleshooting steps possible only at the computer system itself. Ensure that the system documentation is available.



NOTICE: Before servicing any components inside your computer, see your *System Information Guide* for important safety information.

[Back to Contents Page](#)

[Back to Contents Page](#)

Contacting Dell: Dell™ PowerVault™ 160T Tape Library User's Guide

To contact Dell electronically, you can access the following websites:

- www.dell.com
- support.dell.com (technical support)
- premiersupport.dell.com (technical support for educational, government, healthcare, and medium/large business customers, including Premier, Platinum, and Gold customers)

For specific web addresses for your country, find the appropriate country section in the table below.

 **NOTE:** Toll-free numbers are for use within the country for which they are listed.

When you need to contact Dell, use the electronic addresses, telephone numbers, and codes provided in the following table. If you need assistance in determining which codes to use, contact a local or an international operator.

Country (City) International Access Code Country Code City Code	Department Name or Service Area, Website and E-Mail Address	Area Codes, Local Numbers, and Toll-Free Numbers
Anguilla	General Support	toll-free: 800-335-0031
Antigua and Barbuda	General Support	1-800-805-5924
Argentina (Buenos Aires) International Access Code: 00 Country Code: 54 City Code: 11	Website: www.dell.com.ar	
	Tech Support and Customer Care	toll-free: 0-800-444-0733
	Sales	0-810-444-3355
	Tech Support Fax	11 4515 7139
	Customer Care Fax	11 4515 7138
Aruba	General Support	toll-free: 800-1578
Australia (Sydney) International Access Code: 0011 Country Code: 61 City Code: 2	E-mail (Australia): au_tech_support@dell.com	
	E-mail (New Zealand): nz_tech_support@dell.com	
	Home and Small Business	1-300-65-55-33
	Government and Business	toll-free: 1-800-633-559
	Preferred Accounts Division (PAD)	toll-free: 1-800-060-889
	Customer Care	toll-free: 1-800-819-339
	Corporate Sales	toll-free: 1-800-808-385
	Transaction Sales	toll-free: 1-800-808-312
	Fax	toll-free: 1-800-818-341
Austria (Vienna) International Access Code: 900 Country Code: 43	Website: support.euro.dell.com	
	E-mail: tech_support_central_europe@dell.com	
	Home/Small Business Sales	01 795 67602

City Code: 1	Home/Small Business Fax	01 795 67605
	Home/Small Business Customer Care	01 795 67603
	Preferred Accounts/Corporate Customer Care	0660 8056
	Home/Small Business Technical Support	01 795 67604
	Preferred Accounts/Corporate Technical Support	0660 8779
	Switchboard	01 491 04 0
Bahamas	General Support	toll-free: 1-866-278-6818
Barbados	General Support	1-800-534-3066
Belgium (Brussels) International Access Code: 00 Country Code: 32 City Code: 2	Website: support.euro.dell.com	
	E-mail: tech_be@dell.com	
	E-mail for French Speaking Customers: support.euro.dell.com/be/fr/emaildell/	
	Technical Support	02 481 92 88
	Customer Care	02 481 91 19
	Home/Small Business Sales	toll-free: 0800 16884
	Corporate Sales	02 481 91 00
	Fax	02 481 92 99
	Switchboard	02 481 91 00
Bermuda	General Support	1-800-342-0671
Bolivia	General Support	toll-free: 800-10-0238
Brazil International Access Code: 00 Country Code: 55 City Code: 51	Website: www.dell.com/br	
	Customer Support, Technical Support	0800 90 3355
	Tech Support Fax	51 481 5470
	Customer Care Fax	51 481 5480
	Sales	0800 90 3390
British Virgin Islands	General Support	toll-free: 1-866-278-6820
Brunei Country Code: 673	Customer Technical Support (Penang, Malaysia)	604 633 4966
	Customer Service (Penang, Malaysia)	604 633 4949
	Transaction Sales (Penang, Malaysia)	604 633 4955
Canada (North York, Ontario) International Access Code: 011	Automated Order-Status System	toll-free: 1-800-433-9014
	AutoTech (automated technical support)	toll-free: 1-800-247-9362
	TechFax	toll-free: 1-800-950-1329
	Customer Care (home/small business)	toll-free: 1-800-847-4096
	Customer Care (med./ large business, government)	toll-free: 1-800-326-9463
	Technical Support (home/small business)	toll-free: 1-800-847-4096
	Technical Support (med./ large business, gov.)	toll-free: 1-800-387-5757
	Sales (direct sales—from outside Toronto)	toll-free: 1-800-387-5752
	Sales (direct sales—from within Toronto)	416 758-2200
	Sales (federal government, education, and medical)	toll-free: 1-800-567-7542

Cayman Islands	General Support	1-800-805-7541
Chile (Santiago) Country Code: 56 City Code: 2	Sales, Customer Support, and Technical Support	toll-free: 1230-020-4823
China (Xiamen) Country Code: 86 City Code: 592	Tech Support website: support.ap.dell.com/china	
	Tech Support E-mail: cn_support@dell.com	
	Tech Support Fax	818 1350
	Home and Small Business Technical Support	toll-free: 800 858 2437
	Corporate Accounts Technical Support	toll-free: 800 858 2333
	Customer Experience	toll-free: 800 858 2060
	Home and Small Business	toll-free: 800 858 2222
	Preferred Accounts Division	toll-free: 800 858 2062
	Large Corporate Accounts GCP	toll-free: 800 858 2055
	Large Corporate Accounts Key Accounts	toll-free: 800 858 2628
	Large Corporate Accounts North	toll-free: 800 858 2999
	Large Corporate Accounts North Government and Education	toll-free: 800 858 2955
	Large Corporate Accounts East	toll-free: 800 858 2020
	Large Corporate Accounts East Government and Education	toll-free: 800 858 2669
	Large Corporate Accounts Queue Team	toll-free: 800 858 2572
Large Corporate Accounts South	toll-free: 800 858 2355	
Large Corporate Accounts West	toll-free: 800 858 2811	
Large Corporate Accounts Spare Parts	toll-free: 800 858 2621	
Colombia	General Support	980-9-15-3978
Costa Rica	General Support	0800-012-0435
Czech Republic (Prague) International Access Code: 00 Country Code: 420 City Code: 2	Website: support.euro.dell.com	
	E-mail: czech_dell@dell.com	
	Technical Support	02 22 83 27 27
	Customer Care	02 22 83 27 11
	Fax	02 22 83 27 14
	TechFax	02 22 83 27 28
	Switchboard	02 22 83 27 11
Denmark (Copenhagen) International Access Code: 00 Country Code: 45	Website: support.euro.dell.com	
	E-mail Support (portable computers): den_nbk_support@dell.com	
	E-mail Support (desktop computers): den_support@dell.com	
	E-mail Support (servers): Nordic_server_support@dell.com	
	Technical Support	7023 0182
	Customer Care (Relational)	7023 0184
	Home/Small Business Customer Care	3287 5505

	Switchboard (Relational)	3287 1200
	Fax Switchboard (Relational)	3287 1201
	Switchboard (Home/Small Business)	3287 5000
	Fax Switchboard (Home/Small Business)	3287 5001
Dominica	General Support	toll-free: 1-866-278-6821
Dominican Republic	General Support	1-800-148-0530
Ecuador	General Support	toll-free: 999-119
El Salvador	General Support	01-899-753-0777
Finland (Helsinki)	Website: support.euro.dell.com	
International Access Code: 990	E-mail: fin_support@dell.com	
Country Code: 358	E-mail Support (servers): Nordic_support@dell.com	
City Code: 9	Technical Support	09 253 313 60
	Technical Support Fax	09 253 313 81
	Relational Customer Care	09 253 313 38
	Home/Small Business Customer Care	09 693 791 94
	Fax	09 253 313 99
	Switchboard	09 253 313 00
France (Paris) (Montpellier)	Website: support.euro.dell.com	
International Access Code: 00	E-mail: support.euro.dell.com/fr/fr/emaildell/	
Country Code: 33	Home and Small Business	
City Codes: (1) (4)	Technical Support	0825 387 270
	Customer Care	0825 823 833
	Switchboard	0825 004 700
	Switchboard (calls from outside of France)	04 99 75 40 00
	Sales	0825 004 700
	Fax	0825 004 701
	Fax (calls from outside of France)	04 99 75 40 01
	Corporate	
	Technical Support	0825 004 719
	Customer Care	0825 338 339
	Switchboard	01 55 94 71 00
	Sales	01 55 94 71 00
	Fax	01 55 94 71 01
Germany (Langen)	Website: support.euro.dell.com	
International Access Code: 00	E-mail: tech_support_central_europe@dell.com	
Country Code: 49	Technical Support	06103 766-7200
City Code: 6103	Home/Small Business Customer Care	0180-5-224400
	Global Segment Customer Care	06103 766-9570
	Preferred Accounts Customer Care	06103 766-9420

	Large Accounts Customer Care	06103 766-9560
	Public Accounts Customer Care	06103 766-9555
	Switchboard	06103 766-7000
Grenada	General Support	toll-free: 1-866-540-3355
Guatemala	General Support	1-800-999-0136
Guyana	General Support	toll-free: 1-877-270-4609
Hong Kong International Access Code: 001 Country Code: 852	Technical Support (Dimension™ and Inspiron™)	296 93188
	Technical Support (OptiPlex™, Latitude™, and Dell Precision™)	296 93191
	Customer Service (non-technical, post-sales issues)	800 93 8291
	Transaction Sales	toll-free: 800 96 4109
	Large Corporate Accounts HK	toll-free: 800 96 4108
	Large Corporate Accounts GCP HK	toll-free: 800 90 3708
India	Technical Support	1600 33 8045
	Sales	1600 33 8044
Ireland (Cherrywood) International Access Code: 16 Country Code: 353 City Code: 1	Website: support.euro.dell.com	
	E-mail: dell_direct_support@dell.com	
	Ireland Technical Support	1850 543 543
	U.K. Technical Support (dial within U.K. only)	0870 908 0800
	Home User Customer Care	01 204 4095
	Small Business Customer Care	01 204 4444
	U.K. Customer Care (dial within U.K. only)	0870 906 0010
	Corporate Customer Care	01 204 4003
	Ireland Sales	01 204 4444
	U.K. Sales (dial within U.K. only)	0870 907 4000
	SalesFax	01 204 0144
	Fax	01 204 5960
	Switchboard	01 204 4444
Italy (Milan) International Access Code: 00 Country Code: 39 City Code: 02	Website: support.euro.dell.com	
	E-mail: support.euro.dell.com/it/it/emaildell/	
	Home and Small Business	
	Technical Support	02 577 826 90
	Customer Care	02 696 821 14
	Fax	02 696 821 13
	Switchboard	02 696 821 12
	Corporate	
	Technical Support	02 577 826 90
	Customer Care	02 577 825 55

	Fax	02 575 035 30
	Switchboard	02 577 821
Jamaica	General Support (dial from within Jamaica only)	1-800-682-3639
Japan (Kawasaki)	Website: support.jp.dell.com	
International Access Code: 001	Technical Support (servers)	toll-free: 0120-198-498
Country Code: 81	Technical Support outside of Japan (servers)	81-44-556-4162
City Code: 44	Technical Support (Dimension™ and Inspiron™)	toll-free: 0120-198-226
	Technical Support outside of Japan (Dimension and Inspiron)	81-44-520-1435
	Technical Support (Dell Precision™, OptiPlex™, and Latitude™)	toll-free: 0120-198-433
	Technical Support outside of Japan (Dell Precision, OptiPlex, and Latitude)	81-44-556-3894
	24-Hour Automated Order Service	044-556-3801
	Customer Care	044-556-4240
	Business Sales Division (up to 400 employees)	044-556-1465
	Preferred Accounts Division Sales (over 400 employees)	044-556-3433
	Large Corporate Accounts Sales (over 3500 employees)	044-556-3430
	Public Sales (government agencies, educational institutions, and medical institutions)	044-556-1469
	Global Segment Japan	044-556-3469
	Individual User	044-556-1760
	Faxbox Service	044-556-3490
	Switchboard	044-556-4300
Korea (Seoul)	Technical Support	toll-free: 080-200-3800
International Access Code: 001	Sales	toll-free: 080-200-3600
Country Code: 82	Customer Service (Seoul, Korea)	toll-free: 080-200-3800
City Code: 2	Customer Service (Penang, Malaysia)	604 633 4949
	Fax	2194-6202
	Switchboard	2194-6000
Latin America	Customer Technical Support (Austin, Texas, U.S.A.)	512 728-4093
	Customer Service (Austin, Texas, U.S.A.)	512 728-3619
	Fax (Technical Support and Customer Service) (Austin, Texas, U.S.A.)	512 728-3883
	Sales (Austin, Texas, U.S.A.)	512 728-4397
	SalesFax (Austin, Texas, U.S.A.)	512 728-4600 or 512 728-3772
Luxembourg	Website: support.euro.dell.com	
International Access Code: 00	E-mail: tech_be@dell.com	
Country Code: 352	Technical Support (Brussels, Belgium)	02 481 92 88
	Home/Small Business Sales (Brussels, Belgium)	toll-free: 080016884

	Corporate Sales (Brussels, Belgium)	02 481 91 00
	Customer Care (Brussels, Belgium)	02 481 91 19
	Fax (Brussels, Belgium)	02 481 92 99
	Switchboard (Brussels, Belgium)	02 481 91 00
Macao	Technical Support	toll-free: 0800 582
Country Code: 853	Customer Service (Penang, Malaysia)	604 633 4949
	Transaction Sales	toll-free: 0800 581
Malaysia (Penang)	Technical Support	toll-free: 1 800 888 298
International Access Code: 00	Customer Service	04 633 4949
Country Code: 60	Transaction Sales	toll-free: 1 800 888 202
City Code: 4	Corporate Sales	toll-free: 1 800 888 213
Mexico	Customer Technical Support	001-877-384-8979 or 001-877-269-3383
International Access Code: 00	Sales	50-81-8800 or 01-800-888-3355
Country Code: 52	Customer Service	001-877-384-8979 or 001-877-269-3383
	Main	50-81-8800 or 01-800-888-3355
Montserrat	General Support	toll-free: 1-866-278-6822
Netherlands Antilles	General Support	001-800-882-1519
Netherlands (Amsterdam)	Website: support.euro.dell.com	
International Access Code: 00	E-mail (technical support):	
Country Code: 31	(Enterprise): nl_server_support@dell.com	
City Code: 20	(Latitude): nl_latitude_support@dell.com	
	(Inspiron): nl_inspiron_support@dell.com	
	(Dimension): nl_dimension_support@dell.com	
	(OptiPlex): nl_optiplex_support@dell.com	
	(Dell Precision): nl_workstation_support@dell.com	
	Technical Support	020 674 45 00
	Technical Support Fax	020 674 47 66
	Home/Small Business Customer Care	020 674 42 00
	Relational Customer Care	020 674 43 25
	Home/Small Business Sales	020 674 55 00
	Relational Sales	020 674 50 00
	Home/Small Business Sales Fax	020 674 47 75

	Relational Sales Fax	020 674 47 50
	Switchboard	020 674 50 00
	Switchboard Fax	020 674 47 50
New Zealand International Access Code: 00 Country Code: 64	E-mail (New Zealand): nz_tech_support@dell.com	
	E-mail (Australia): au_tech_support@dell.com	
	Home and Small Business	0800 446 255
	Government and Business	0800 444 617
	Sales	0800 441 567
	Fax	0800 441 566
Nicaragua	General Support	001-800-220-1006
Norway (Lysaker) International Access Code: 00 Country Code: 47	Website: support.euro.dell.com	
	E-mail Support (portable computers): nor_nbk_support@dell.com	
	E-mail Support (desktop computers): nor_support@dell.com	
	E-mail Support (servers): nordic_server_support@dell.com	
	Technical Support	671 16882
	Relational Customer Care	671 17514
	Home/Small Business Customer Care	23162298
	Switchboard	671 16800
	Fax Switchboard	671 16865
Panama	General Support	001-800-507-0962
Peru	General Support	0800-50-669
Poland (Warsaw) International Access Code: 011 Country Code: 48 City Code: 22	Website: support.euro.dell.com	
	E-mail: pl_support@dell.com	
	Customer Service Phone	57 95 700
	Customer Care	57 95 999
	Sales	57 95 999
	Customer Service Fax	57 95 806
	Reception Desk Fax	57 95 998
	Switchboard	57 95 999
Portugal International Access Code: 00	E-mail: support.euro.dell.com/es/es/emaildell/	
	Technical Support	800 834 077

Country Code: 35	Customer Care	800 300 415 or 800 834 075
	Sales	800 300 410 or 800 300 411 or 800 300 412 or 121 422 07 10
	Fax	121 424 01 12
Puerto Rico	General Support	1-800-805-7545
St. Kitts and Nevis	General Support	toll-free: 1-877-441-4731
St. Lucia	General Support	1-800-882-1521
St. Vincent and the Grenadines	General Support	toll-free: 1-877-270-4609
Singapore (Singapore) International Access Code: 005 Country Code: 65	Technical Support	toll-free: 800 6011 051
	Customer Service (Penang, Malaysia)	604 633 4949
	Transaction Sales	toll-free: 800 6011 054
	Corporate Sales	toll-free: 800 6011 053
South Africa (Johannesburg) International Access Code: 09/091 Country Code: 27 City Code: 11	Website: support.euro.dell.com	
	E-mail: dell_za_support@dell.com	
	Technical Support	011 709 7710
	Customer Care	011 709 7707
	Sales	011 709 7700
	Fax	011 706 0495
	Switchboard	011 709 7700
Southeast Asian and Pacific Countries	Customer Technical Support, Customer Service, and Sales (Penang, Malaysia)	604 633 4810
Spain (Madrid) International Access Code: 00 Country Code: 34 City Code: 91	Website: support.euro.dell.com	
	E-mail: support.euro.dell.com/es/es/emaildell/	
	Home and Small Business	
	Technical Support	902 100 130
	Customer Care	902 118 540
	Sales	902 118 541
	Switchboard	902 118 541
	Fax	902 118 539
	Corporate	
	Technical Support	902 100 130
	Customer Care	902 118 546
	Switchboard	91 722 92 00
Fax	91 722 95 83	
Sweden (Upplands Vasby) International Access Code:	Website: support.euro.dell.com	
	E-mail: swe_support@dell.com	

00 Country Code: 46 City Code: 8	E-mail Support for Latitude and Inspiron: Swe-nbk_kats@dell.com	
	E-mail Support for OptiPlex: Swe_kats@dell.com	
	E-mail Support for Servers: Nordic_server_support@dell.com	
	Technical Support	08 590 05 199
	Relational Customer Care	08 590 05 642
	Home/Small Business Customer Care	08 587 70 527
	Employee Purchase Program (EPP) Support	20 140 14 44
	Fax Technical Support	08 590 05 594
	Sales	08 590 05 185
Switzerland (Geneva) International Access Code: 00 Country Code: 41 City Code: 22	Website: support.euro.dell.com	
	E-mail: swisstech@dell.com	
	E-mail for French-speaking HSB and Corporate Customers: support.euro.dell.com/ch/fr/emaildell/	
	Technical Support (Home and Small Business)	0844 811 411
	Technical Support (Corporate)	0844 822 844
	Customer Care (Home and Small Business)	0848 802 202
	Customer Care (Corporate)	0848 821 721
	Fax	022 799 01 90
Switchboard	022 799 01 01	
Taiwan International Access Code: 002 Country Code: 886	Technical Support (portable and desktop computers)	toll-free: 00801 86 1011
	Technical Support (servers)	toll-free: 0080 60 1256
	Transaction Sales	toll-free: 0080 651 228 or 0800 33 556
	Corporate Sales	toll-free: 0080 651 227 or 0800 33 555
Thailand International Access Code: 001 Country Code: 66	Technical Support	toll-free: 0880 060 07
	Customer Service (Penang, Malaysia)	604 633 4949
	Sales	toll-free: 0880 060 09
Trinidad/Tobago	General Support	1-800-805-8035
Turks and Caicos Islands	General Support	toll-free: 1-866-540-3355
U.K. (Bracknell) International Access Code: 00 Country Code: 44 City Code: 1344	Website: support.euro.dell.com	
	Customer Care website: dell.co.uk/lca/customerservices	
	E-mail: dell_direct_support@dell.com	
	Technical Support (Corporate/Preferred Accounts/PAD [1000+ employees])	0870 908 0500
	Technical Support (direct/PAD and general)	0870 908 0800
	Global Accounts Customer Care	01344 373 185

		or 01344 373 186
	Home and Small Business Customer Care	0870 906 0010
	Corporate Customer Care	0870 908 0500
	Preferred Accounts (500–5000 employees) Customer Care	01344 373 196
	Central Government Customer Care	01344 373 193
	Local Government & Education Customer Care	01344 373 199
	Health Customer Care	01344 373 194
	Home and Small Business Sales	0870 907 4000
	Corporate/Public Sector Sales	01344 860 456
Uruguay	General Support	toll-free: 000-413-598-2521
U.S.A. (Austin, Texas)	Automated Order-Status Service	toll-free: 1-800-433-9014
International Access Code: 011	AutoTech (portable and desktop computers)	toll-free: 1-800-247-9362
Country Code: 1	Consumer (Home and Home Office)	
	Technical Support	toll-free: 1-800-624-9896
	Customer Service	toll-free: 1-800-624-9897
	DellNet™ Service and Support	toll-free: 1-877-Dellnet (1-877-335-5638)
	Employee Purchase Program (EPP) Customers	toll-free: 1-800-695-8133
	Financial Services website: www.dellfinancialservices.com	
	Financial Services (lease/loans)	toll-free: 1-877-577-3355
	Financial Services (Dell Preferred Accounts [DPA])	toll-free: 1-800-283-2210
	Business	
	Customer Service and Technical Support	toll-free: 1-800-822-8965
	Employee Purchase Program (EPP) Customers	toll-free: 1-800-695-8133
	Projectors Technical Support	toll-free: 1-877-459-7298
	Public (government, education, and healthcare)	
	Customer Service and Technical Support	toll-free: 1-800-234-1490
	Employee Purchase Program (EPP) Customers	toll-free: 1-800-695-8133
	Dell Sales	toll-free: 1-800-289-3355 or toll-free: 1-800-879-3355
	Dell Outlet Store (Dell refurbished computers)	toll-free: 1-888-798-7561
	Software and Peripherals Sales	toll-free: 1-800-671-3355
	Spare Parts Sales	toll-free: 1-800-357-3355
	Extended Service and Warranty Sales	toll-free: 1-800-247-4618
	Fax	toll-free: 1-800-727-8320
	Dell Services for the Deaf, Hard-of-Hearing, or Speech-Impaired	toll-free: 1-877-DELLTTY (1-877-335-5889)

U.S. Virgin Islands	General Support	1-877-673-3355
Venezuela	General Support	8001-3605

[Back to Contents Page](#)

[Back to Contents Page](#)

Specifications: Dell™ PowerVault™ 160T Tape Library User's Guide

- [Performance Specifications](#)
- [Environmental Specifications](#)
- [Electrical Specifications](#)
- [Physical Specifications](#)
- [Barcode Requirements](#)

This section provides performance, environmental, electrical, and physical specifications for modules in the Dell PowerVault 160T Tape Library.

Performance Specifications

Library performance is 180 cartridge exchanges per hour (EPH) for a four module system with a maximum EPH of 265.

Environmental Specifications

[Table 1](#) lists the key environmental information for the Dell PowerVault 160T Tape Library.

Table 1. Environmental Specifications

Temperature	Humidity	Altitude	BTU/Heat Dissipation	
			Minimum ¹	Maximum ²
59 °F - 89.6 °F (15 °C - 32 °C)	15 - 75%	10000 ft	.375 kwh 1280 BTU	4.3 kwh 14651 BTU
¹ Configuration includes a control module with one drive. ² Configuration includes a control module and three expansion modules with a total of 48 drives.				

Electrical Specifications

Each system is configured with a redundant power configuration. Both control and expansion modules require two independent AC power sources.

-  **NOTICE:** You must install your library with two different power sources to have redundant power. You will NOT have redundant power if you use only one AC power source. If a power failure occurs, your library will fail.

The power cable length for each of these inputs is 14 feet (4.26 m). Refer to [Table 2](#).

Table 2. Electrical Specifications

Module	Voltage (Single Phase, 50 - 60 Hz)	Max AMP Rating	United States Power Connector (220V)	United States Power Connector (110V)
Control	100 - 240	30	L6 - 30	L5 - 30
Expansion	100 - 240	30	L6 - 30	L5 - 30

 **NOTICE:** Connect an 18 gauge stranded copper wire from the control module to earth ground.

The typical power consumption for each module is shown in [Table 3](#).

Table 3. Typical Module Power Consumption

Module	AMP @ 110 V	AMP @ 220 V	kW	BTU/hr
Control				
Minimum (1 drive)	3.4	1.7	.375	1280
Maximum (12 drives)	12	6	1.32	4508
Expansion				
Minimum (no drives)	0	0	0	0
Maximum (12 drives)	9	4.5	.99	3381

Physical Specifications

This section contains the physical specifications for the library modules comprising the Dell PowerVault 160T Tape Library.

If the library is installed on a raised floor, the raised floor should be stabilized to prevent a horizontal shift of the raised floor structure. The library has four point loads each on the control and expansion modules. Refer to [Table 4](#).

Table 4. Physical Specifications

Height	Width	Depth	Maximum Weight	Distributed Load	Point Load
CAUTION: Control Module ¹					
77.4 in. 1965.9 mm	24.3 in. 616.7 mm	38.3 in. 973.9 mm	899 lb 408.6 kg	139.1 lb/ft ² 680.4 kg/m ²	73.8 lb/in ² 5.2 kg/cm ²
CAUTION: Expansion Module ²					
77.4 in. 1965.9 mm	23.6 in. 599 mm	38.3 in. 973.9 mm	885 lb 402.3 kg	140.9 lb/ft ² 689.6 kg/m ²	72.7 lb/in ² 5.1 kg/cm ²
¹ Includes 12 drives, redundant power, and full media.					
² Includes 12 drives, redundant power, and full media.					

Configuration One

The first configuration consists of the control module. See [Figure 1](#). Physical specifications are listed in [Table 5](#).

Figure 1. Configuration One Diagram

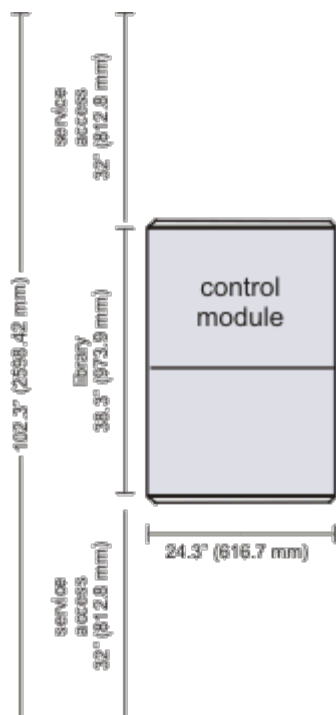

Table 5. Configuration One Specifications

Height	Width	Depth	Maximum Weight	Maximum Distributed Load	Maximum Point Load
77.4 in 1965.9 mm	24.3 in 616.7 mm	38.3 in 973.9 mm	899 lb 408.6 kg	139.1 lb/ft ² 680.4 kg/m ²	73.8 lb/in ² 5.2 kg/cm ²

Configuration Two

The second configuration consists of the control module and one expansion module. See [Figure 2](#). Physical specifications are listed in [Table 6](#).

Figure 2. Configuration Two Diagram

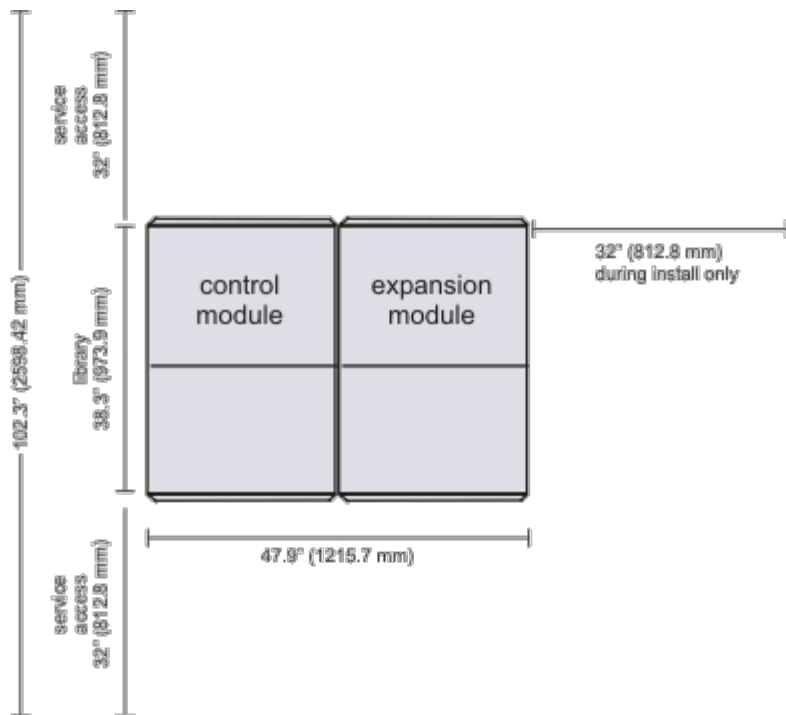

Table 6. Configuration Two Specifications

Height	Width	Depth	Maximum Weight	Maximum Distributed Load	Maximum Point Load
77.4 in. 1965.9 mm	47.9 in. 1215.7mm	38.3 in. 973.9 mm	1784 lb 810.9 kg	140 lb/ft ² 684.9 kg/m ²	73.3 lb/in ² 5.2 kg/cm ²

Configuration Three

The third configuration consists of one control module and two expansion modules. See [Figure 3](#). Physical specifications are listed in [Table 7](#).

Figure 3. Configuration Three Diagram

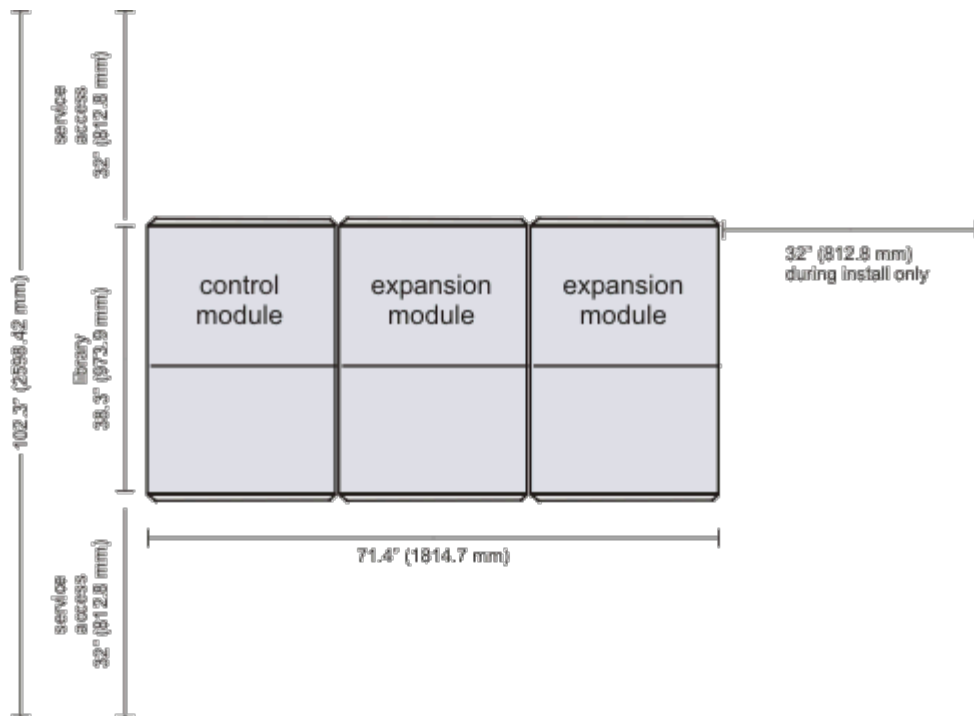

Table 7. Configuration Three Specifications

Height	Width	Depth	Maximum Weight	Maximum Distributed Load	Maximum Point Load
77.4 in. 1965.9 mm	71.4 in. 1814.7 mm	38.3 in. 973.9 mm	2669 lb 1213.2 kg	140.3 lb/ft ² 686.4 kg/m ²	73.1 lb/in ² 5.1 kg/cm ²

Configuration Four

The fourth configuration consists of the control module and three expansion modules. See [Figure 4](#). Physical specifications are listed in [Table 8](#).

Figure 4. Configuration Four Diagram

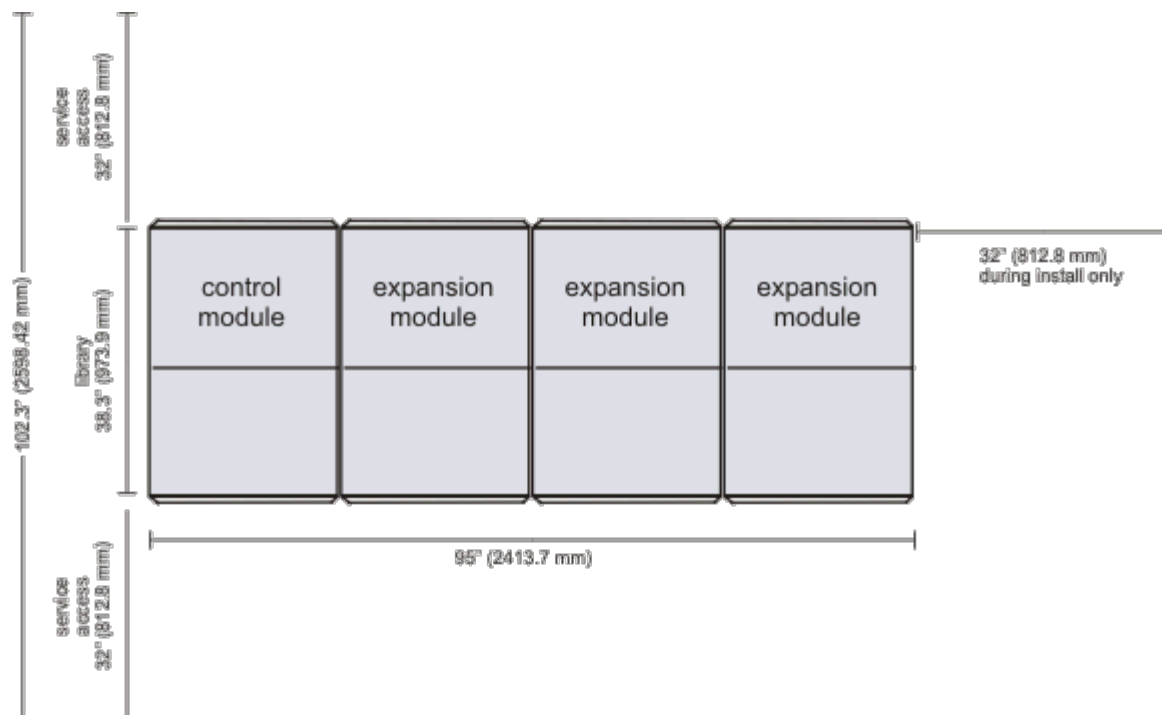

Table 8. Configuration Four Specifications

Height	Width	Depth	Maximum Weight	Maximum Distributed Load	Maximum Point Load
77.4 in. 1965.9 mm	95.0 in. 2413.7 mm	38.3 in. 973.9 mm	3554 lb 1615.5 kg	140.5 lb/ft ² 687.2 kg/m ²	73 lb/in ² 5.1 kg/cm ²

Barcode Requirements

A barcode must use only uppercase letters A to Z and/or numeric values 0 to 9. Your library currently supports Code 39 type barcode labels.

You will have the best scanning results if you use Dell-supplied barcode labels. If you want to print your own barcode labels, ensure the labels meet the following requirements:

- ANSI MH10.8M-1983 Standard
- Number of digits: up to 16
- Background reflection: greater than 25 percent
- Print contrast: greater than 75 percent
- Ratio: greater than 2.2
- Module: 250 mm
- Print tolerance: ± 57 mm

Additional Requirements

- Length of the rest zones: 5.25 mm ± 0.25 mm.
- No black marks should be present in the intermediate spaces or rest zones.
- No white areas should be present on the bars.

[Back to Contents Page](#)